

# Thick film rectangular

## MCR03 (1608 size)

### ●Features

- 1) Power rating of 1 / 10W (FX class: 1 / 16W)
- 2) Highly reliable chip resistor  
Ruthenium oxide resistive material offers superior resistance to the elements.
- 3) Electrodes not corroded by soldering  
Thick film makes the electrodes very strong.
- 4) Resin protective coating for FX resistors

Absorbs impact, facilitates mounting.

- 5) ROHM resistors have approved ISO-9001 certification.

Design and specifications are subject to change without notice. Carefully check the specification sheet supplied with the product before using or ordering it.

### ●Ratings

Item	Conditions	Specifications	
Rated power	Power must be derated according to the power derating curve in Figure 1 when ambient temperature exceeds 70°C.	J, F	0.100W (1 / 10W)
		FX	0.063W (1 / 16W)
		at 70°C	
Rated voltage	The voltage rating is calculated by the following equation. If the value obtained exceeds the maximum operating voltage, the voltage rating is equal to the maximum operating voltage. $E = \sqrt{P \times R}$ E: Rated voltage (V) P: Rated power (W) R: Nominal resistance (Ω)	Max. operating voltage	50V
		Max. overload voltage	100V
		Max. intermittent overload voltage	100V
Nominal resistance	See Table 1.		
Operating temperature		J, F	-55°C to +155°C
		FX	-55°C to +125°C

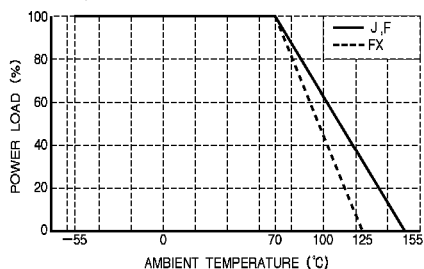

Fig.1

### Jumper type

Resistance	Max. 50mΩ
Rated current	1A
Peak current	3A
Operating temperature	-55°C to +155°C

Table 1

Resistance tolerance	Resistance range (Ω)	Resistance temperature coefficient (ppm / °C)
FX (±1%) (EZP type)	10 ≤ R ≤ 2.2M (E24,96)	±100
F (±1%)	10 ≤ R ≤ 2.2M (E24,96)	±200
	1.0 ≤ R < 2.2 (E24)	500 ± 350
J (±5%)	2.2 ≤ R < 10 (E24)	±500
	10 ≤ R ≤ 10M (E24)	±200

●JW class components are for sale in the American market. With regard to the same resistance ranges for sale in other markets, the components have a guaranteed resistance temperature coefficient of ±200ppm / °C (W).

●Before using components in circuits where they will be exposed to transients such as pulse loads (short-duration, high-level loads), be certain to evaluate the component in the mounted state. In addition, the reliability and performance of this component cannot be guaranteed if it is used with a steady state voltage that is greater than its rated voltage.

● External dimensions (Units: mm)

No.	Material
①	Thick dielectric glaze of ruthenium (only silver used for jumper)
②	Thick film of palladium-silver for primary electrode
③	Nickel-coated secondary electrode
④	External electrode coated with tin and lead
⑤	Alumina substrate
⑥	Overcoating (J, F: glass, FX: resin)

(Part sometimes comes as the separated type.)

● Packaging

Reel

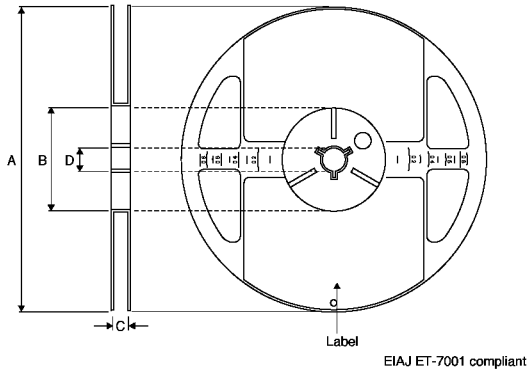

(Units : mm)

A	B	C	D
$\phi 180 \begin{smallmatrix} 0 \\ -3 \end{smallmatrix}$	$\phi 60 \begin{smallmatrix} +1 \\ 0 \end{smallmatrix}$	$9 \pm 0.3$	$\phi 13 \pm 0.2$
$\phi 268 \pm 1.5$	$\phi 100 \pm 0.8$	$9.4 \pm 0.5$	$\phi 13 \pm 0.3$
$\phi 330 \pm 2$	Min. $\phi 80$	$9.5 \pm 0.5$	$\phi 13 \pm 0.2$

Taping

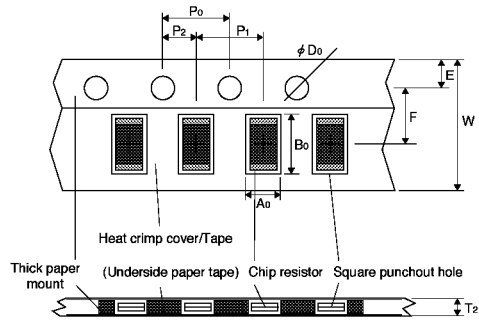

(Units : mm)

W	F	E	A <sub>0</sub>	B <sub>0</sub>
$8.0 \pm 0.3$	$3.5 \pm 0.05$	$1.75 \pm 0.1$	$1.1 \pm 0.1$	$1.9 \pm 0.1$
D <sub>0</sub>	P <sub>0</sub>	P <sub>1</sub>	P <sub>2</sub>	T <sub>2</sub>
$\phi 1.5 \begin{smallmatrix} +0.1 \\ 0 \end{smallmatrix}$	$4.0 \pm 0.1$	$4.0 \pm 0.1$	$2.0 \pm 0.05$	Max. 1.1

Bulk case

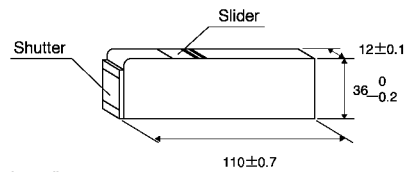

EIAJ ET-7201A compliant

(Units : mm)

● Makeup of the part number

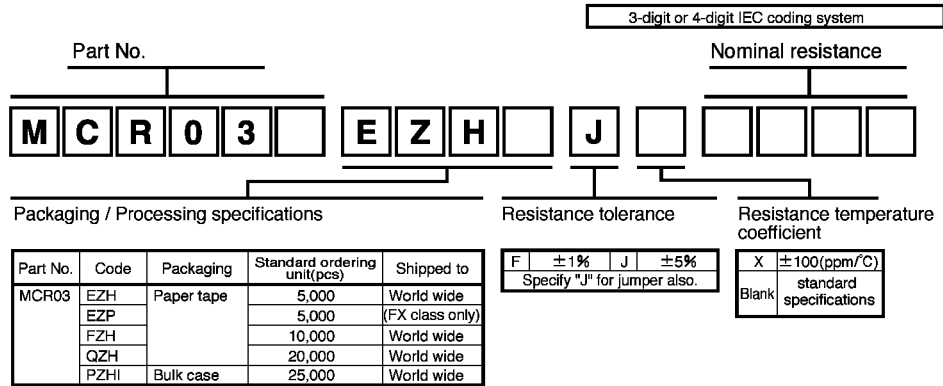

● Dimensions

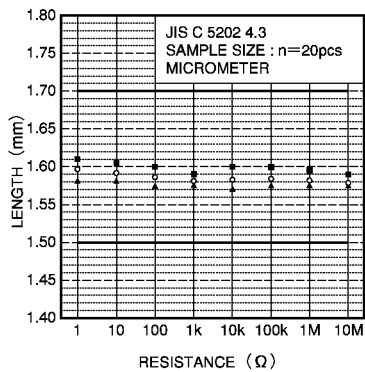

Fig.2 Dimensions (length)

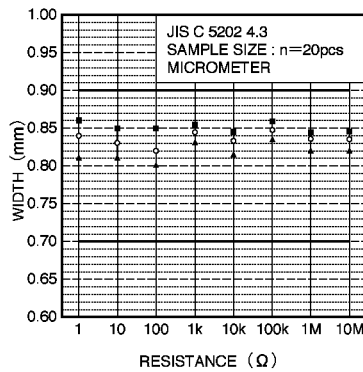

Fig.3 Dimensions (width)

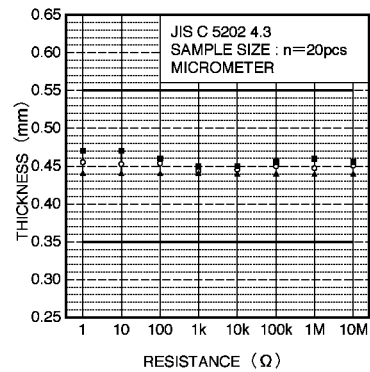

Fig.4 Dimensions (thickness)

● Electrical characteristics

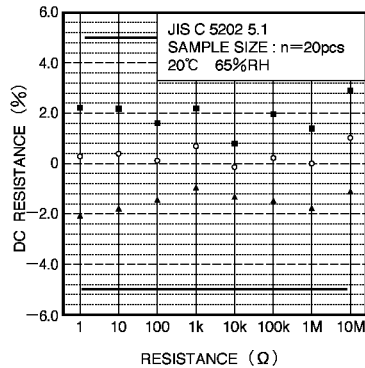

Fig.5 DC resistance

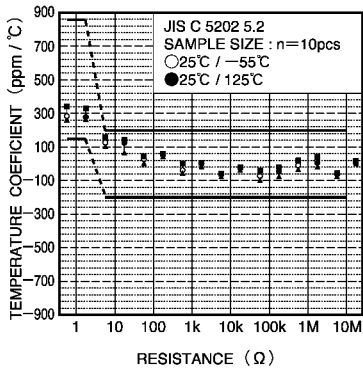

Fig.6 Resistance temperature characteristics

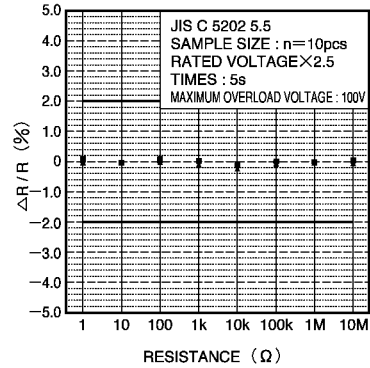

Fig.7 Short time overload