



Absolute Maximum Ratings

Ta = 25°C

		Red	Orange	Yellow		Green	Pure Green	Unit
		BR	AA	AY	PY	PG	BG	
Power Dissipation	Pb	57.5	70	70	70	70	70	mW
Forward Current	IF	25	25	25	25	25	25	mA
Peak Forward Current	IFM	60	60	60	60	60	60	mA
Reverse Voltage	VR	4	4	4	4	4	4	V
Operating Temp.	Topr	-30~+85	-30~+85	-30~+85	-30~+85	-30~+85	-30~+85	°C
Storage Temp.	Tstg	-40~+100	-40~+100	-40~+100	-40~+100	-40~+100	-40~+100	°C
Derating *	ΔIF	0.36(DC), 0.86(Pulse)						mA/°C

* The current derating for operation applies when temperature is above 25°C.

• IFM Condition : tw ≤ 1msec, Duty ≤ 1/20

Electro-Optical Characteristics

Ta = 25°C

Part No.	Chip		Package Color	Luminous Intensity			Wavelength			Forward Voltage			Reverse Current	
	Material	Emitted Color		Iv			λ p	Δλ		VF			IR	
				MIN	TYP	IF	TYP	TYP	IF	TYP	MAX	IF	MAX	VR
BR1111C	GaAlAs	Red	Milky White	7.0	11.7	20	660	30	20	1.7	2.3	20	100	4
AA1111C	GaAsP	Orange		2.0	3.4	20	605	30	20	2.2	2.8	20	100	4
AY1111C	GaAsP	Yellow		2.0	3.4	20	580	30	20	2.2	2.8	20	100	4
PY1111C	GaP			7.0	11.7	20	570	30	20	2.1	2.8	20	100	4
PG1111C	GaP	Green		3.8	6.4	20	560	30	20	2.1	2.8	20	100	4
BG1111C	GaP	Pure Green		1.4	2.4	20	555	30	20	2.1	2.8	20	100	4
Units			mcd	mcd	mA	nm	nm	mA	V	V	mA	μA	V	

Package Dimensions

Unit : mm

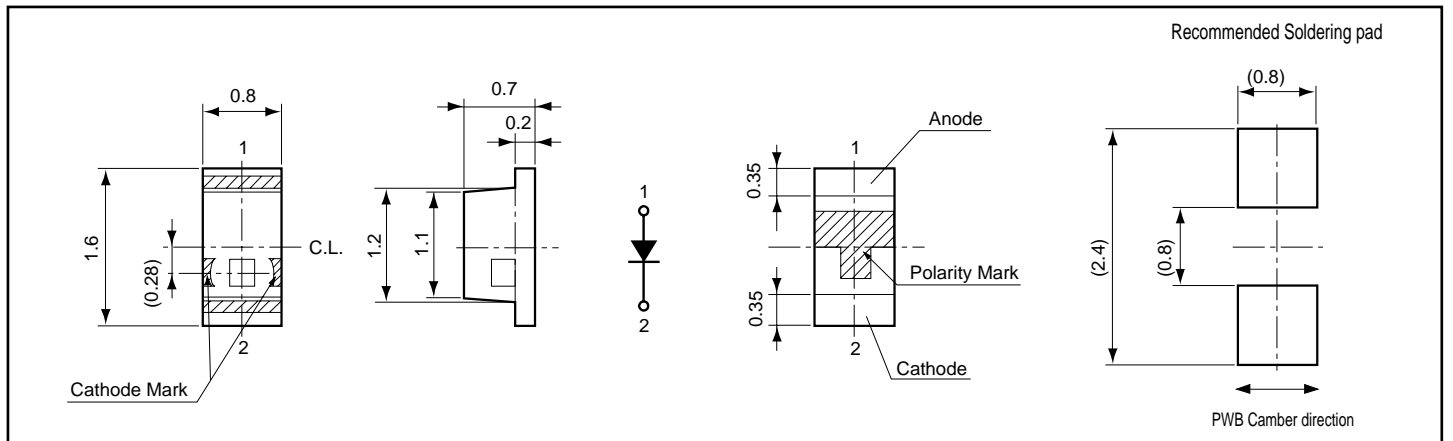

Tolerance : ±0.1mm

Spatial Distribution

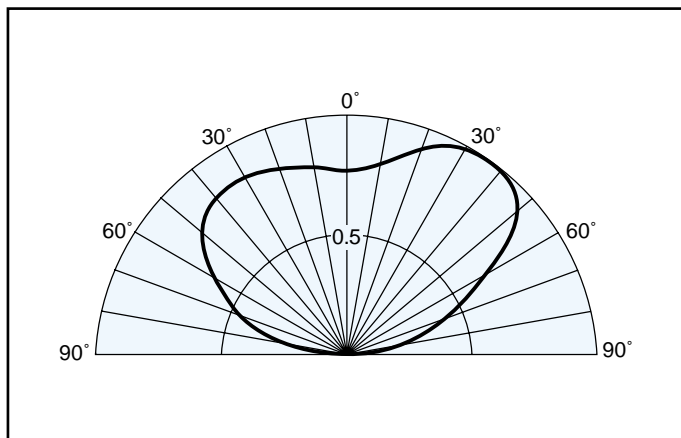

Taping Specification

Unit : mm

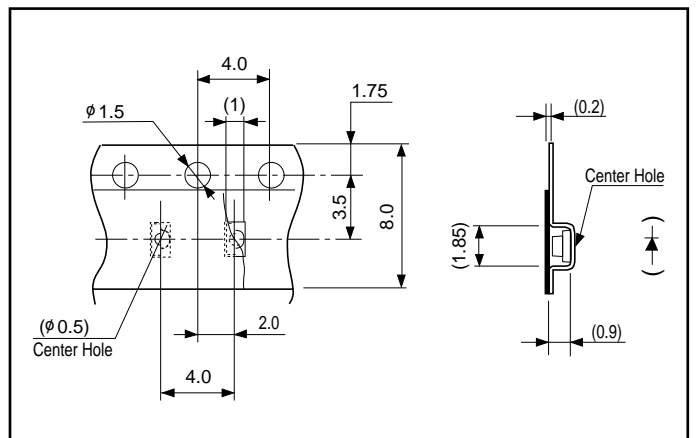

* Quantity 4,000 pcs/Reel

■ Power Dissipation vs. Ambient Temperature

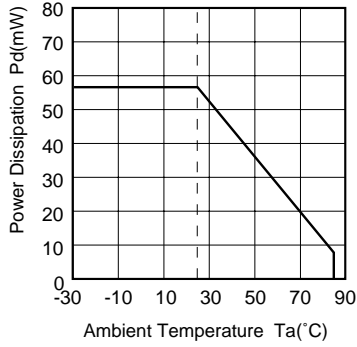

■ Ambient Temperature vs. Maximum Forward Current

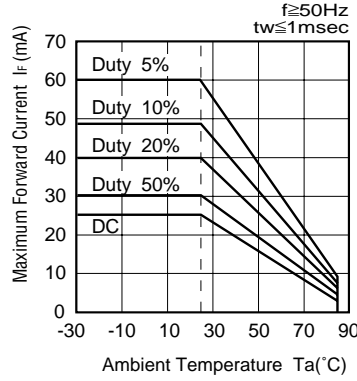

■ Pulse Duration vs. Maximum Tolerable Peak Current

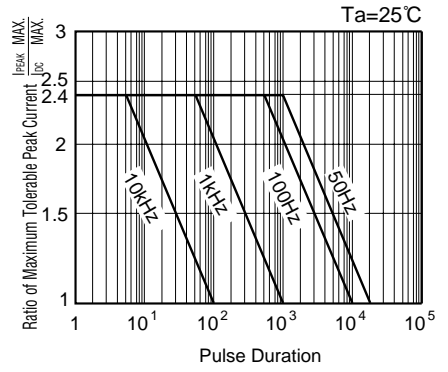

■ Forward Voltage vs. Forward Current

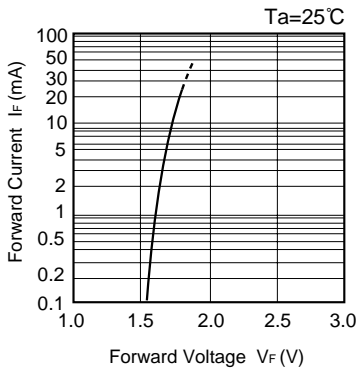

■ Forward Current vs. Relative Intensity

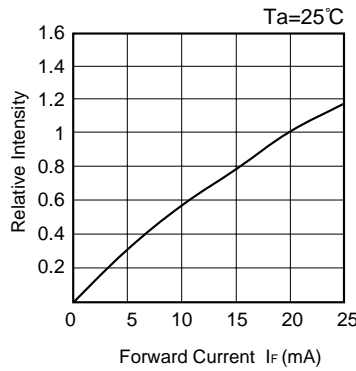

■ Ambient Temperature vs. Relative Intensity

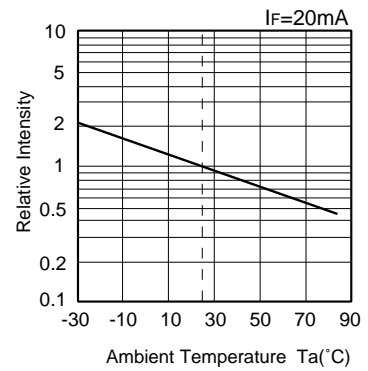

■ Spectral Distribution

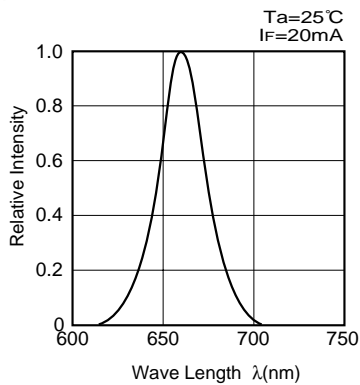

■ Power Dissipation vs. Ambient Temperature

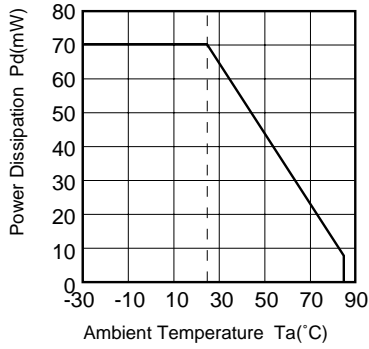

■ Ambient Temperature vs. Maximum Forward Current

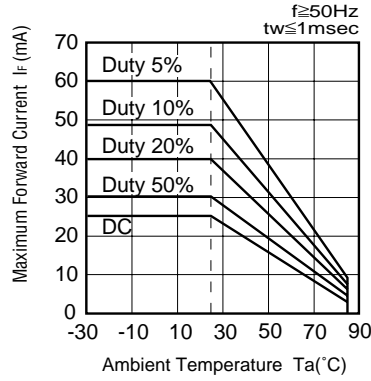

■ Pulse Duration vs. Maximum Tolerable Peak Current

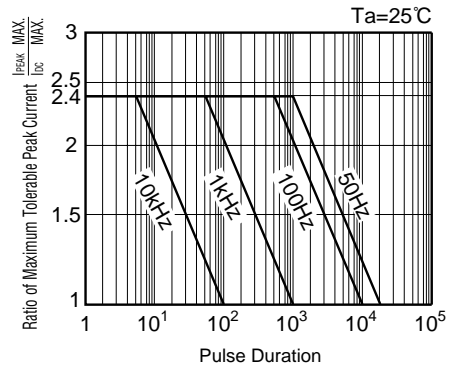

■ Forward Voltage vs. Forward Current

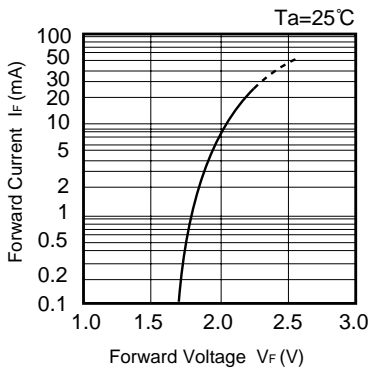

■ Forward Current vs. Relative Intensity

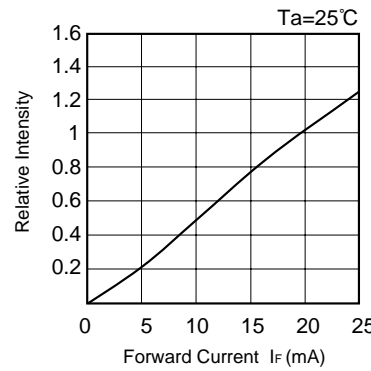

■ Ambient Temperature vs. Relative Intensity

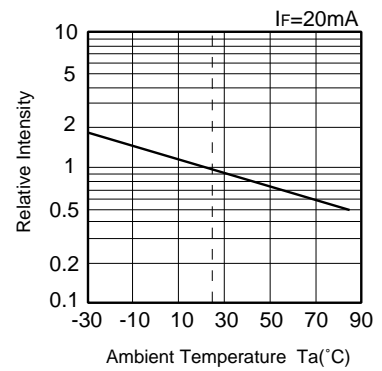

■ Spectral Distribution

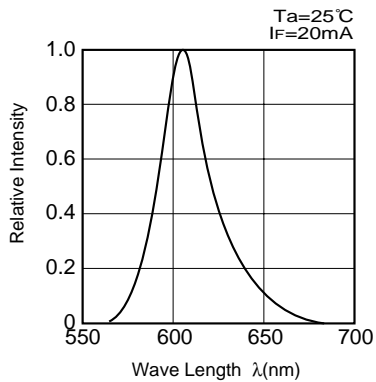

■ Power Dissipation vs. Ambient Temperature

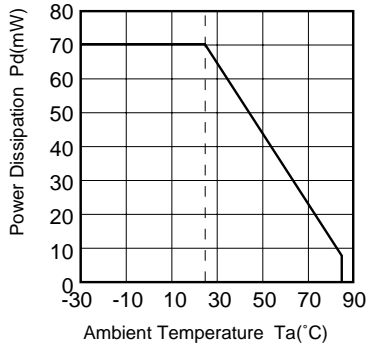

■ Ambient Temperature vs. Maximum Forward Current

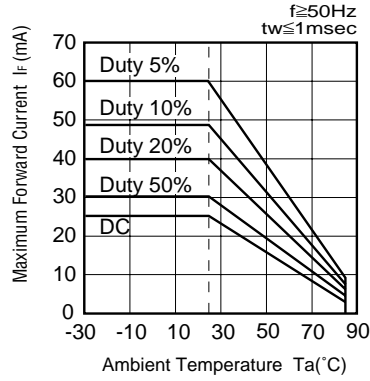

■ Pulse Duration vs. Maximum Tolerable Peak Current

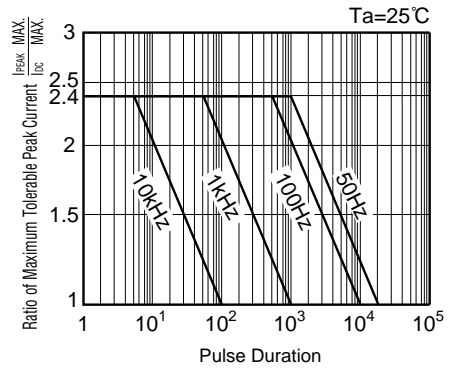

■ Forward Voltage vs. Forward Current

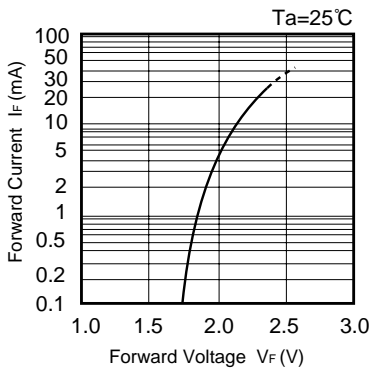

■ Forward Current vs. Relative Intensity

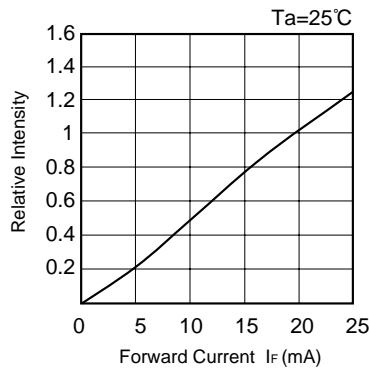

■ Ambient Temperature vs. Relative Intensity

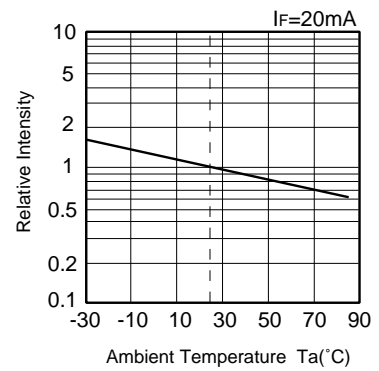

■ Spectral Distribution

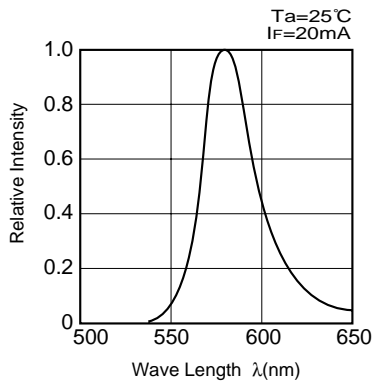

■ Power Dissipation vs. Ambient Temperature

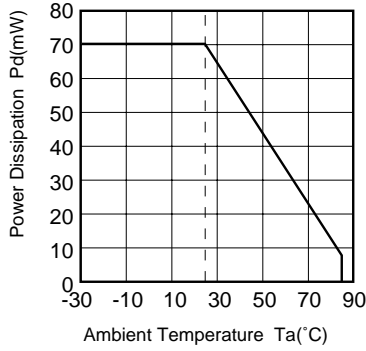

■ Ambient Temperature vs. Maximum Forward Current

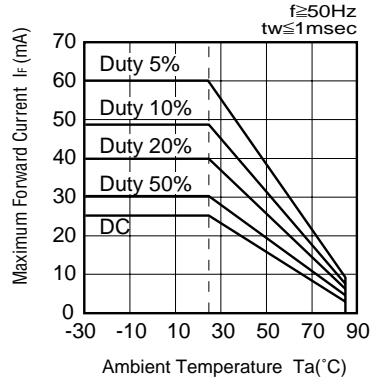

■ Pulse Duration vs. Maximum Tolerable Peak Current

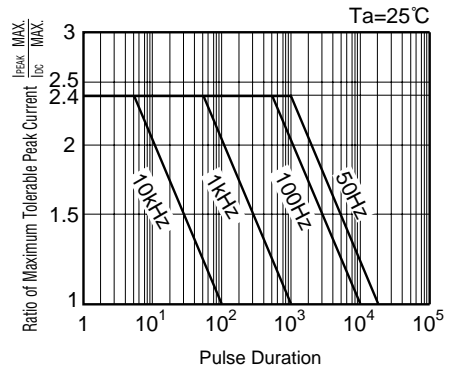

■ Forward Voltage vs. Forward Current

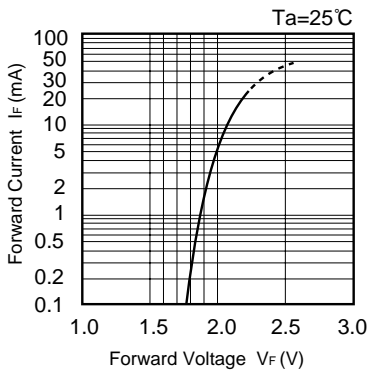

■ Forward Current vs. Relative Intensity

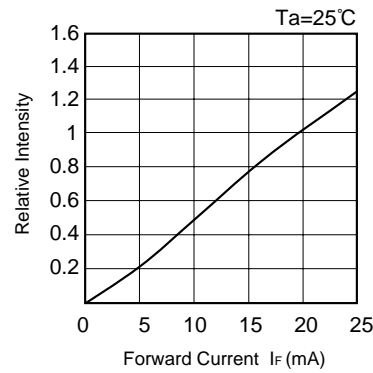

■ Ambient Temperature vs. Relative Intensity

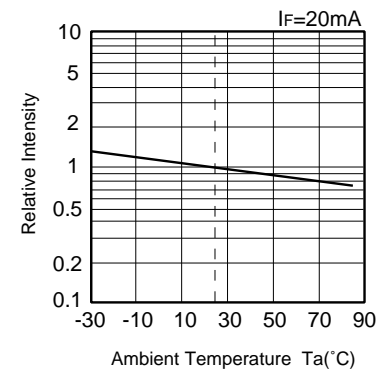

■ Spectral Distribution

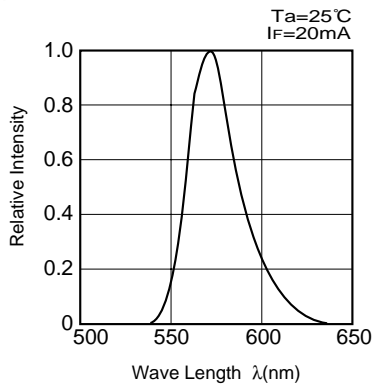

■ Power Dissipation vs. Ambient Temperature

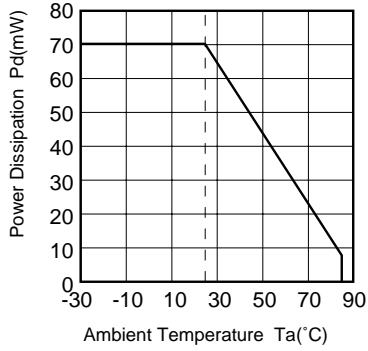

■ Ambient Temperature vs. Maximum Forward Current

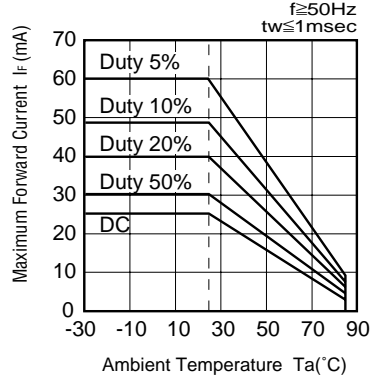

■ Pulse Duration vs. Maximum Tolerable Peak Current

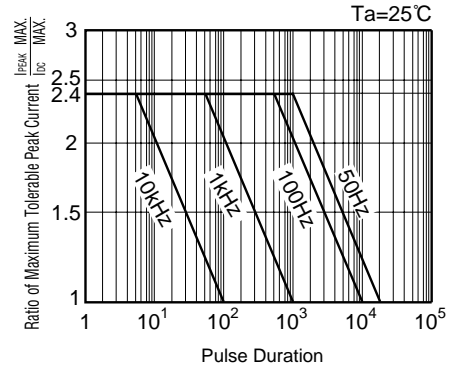

■ Forward Voltage vs. Forward Current

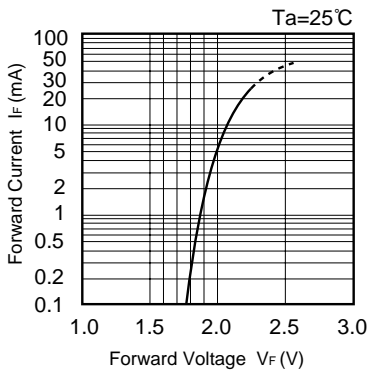

■ Forward Current vs. Relative Intensity

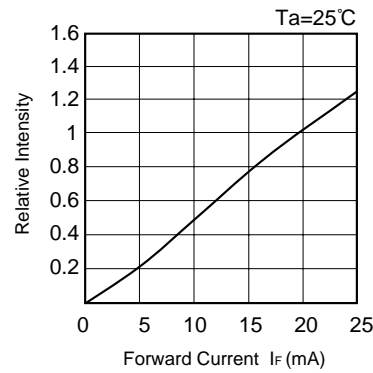

■ Ambient Temperature vs. Relative Intensity

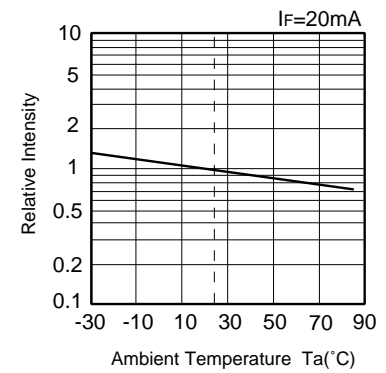

■ Spectral Distribution

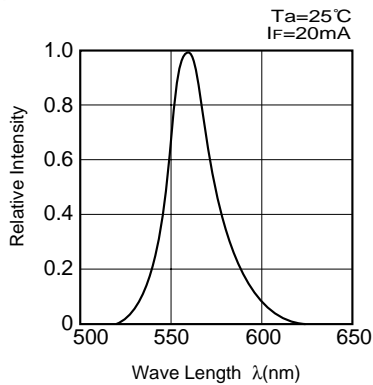

■ Power Dissipation vs. Ambient Temperature

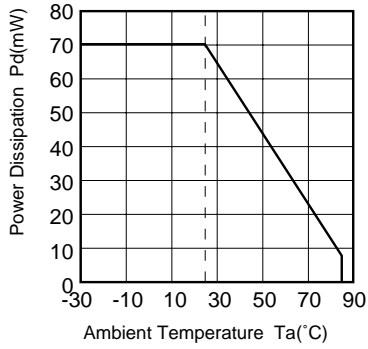

■ Ambient Temperature vs. Maximum Forward Current

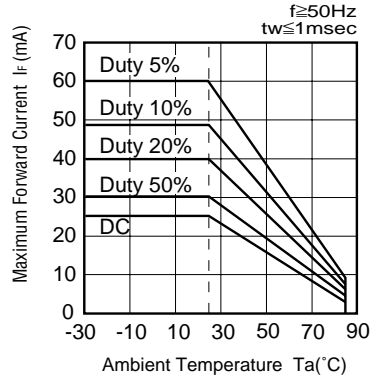

■ Pulse Duration vs. Maximum Tolerable Peak Current

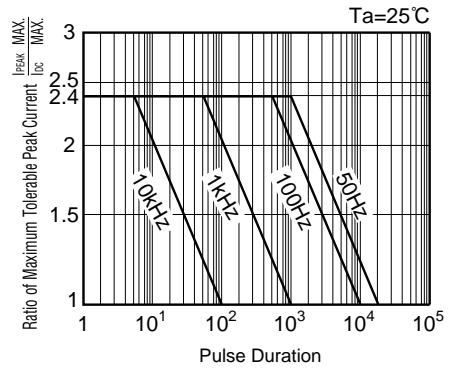

■ Forward Voltage vs. Forward Current

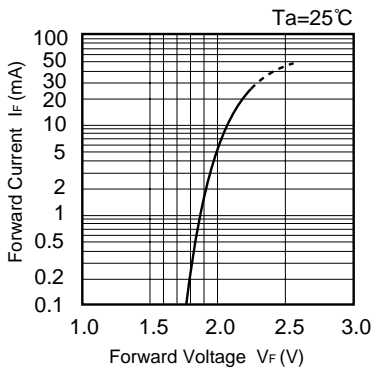

■ Forward Current vs. Relative Intensity

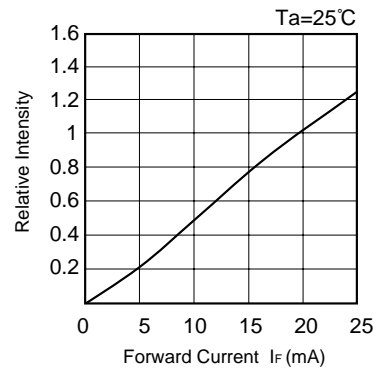

■ Ambient Temperature vs. Relative Intensity

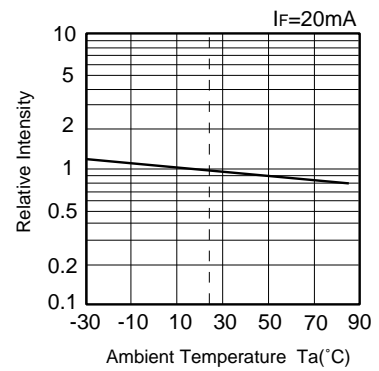

■ Spectral Distribution

