

Three-Terminal Positive Voltage Regulators

These voltage regulators are monolithic integrated circuits designed as fixed-voltage regulators for a wide variety of applications including local, on-card regulation. These regulators employ internal current limiting, thermal shutdown, and safe-area compensation. With adequate heatsinking they can deliver output currents in excess of 1.0 A. Although designed primarily as fixed voltage regulators, these devices can be used with external components to obtain adjustable voltages and currents.

- Output Current in Excess of 1.0 A
- No External Components Required
- Internal Thermal Overload Protection
- Internal Short Circuit Current Limiting
- Output Transistor Safe-Area Compensation
- Output Voltage Offered with a 4% Tolerance
- Available in Surface Mount D²PAK and Standard 3-Lead Transistor Packages

MCT7800 Series

THREE-TERMINAL POSITIVE FIXED VOLTAGE REGULATORS

T SUFFIX
PLASTIC PACKAGE
CASE 221A

Heatsink surface connected to Pin 2.

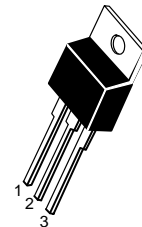

Pin 1. Input
2. Ground
3. Output

D2T SUFFIX
PLASTIC PACKAGE
CASE 936
(D²PAK)

Heatsink surface (shown as terminal 4 in case outline drawing) is connected to Pin 2.

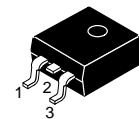

This MCT-prefixed device is intended to be a possible replacement for the similar device with the MC-prefix. Because the MCT device originates from different source material, there may be subtle differences in typical parameter values or characteristic curves. Due to the diversity of potential applications, Motorola can not assure identical performance in all circuits. Motorola recommends that the customer qualify the MCT-prefixed device in each potential application.

DEVICE TYPE/NOMINAL OUTPUT VOLTAGE

MCT7805	5.0 V	MCT7812	12 V
MCT7806	6.0 V	MCT7815	15 V
MCT7808	8.0 V	MCT7818	18 V
MCT7809	9.0 V	MCT7824	24 V

ORDERING INFORMATION

Device	Output Voltage Tolerance	Tested Operating Temperature Range	Package
MCT78XXBD2T	4%	$T_J = -40^\circ \text{ to } +125^\circ \text{C}$	Surface Mount
MCT78XXBT			Insertion Mount
MCT78XXCD2T		$T_J = 0^\circ \text{ to } +125^\circ \text{C}$	Surface Mount
MCT78XXCT			Insertion Mount

XX indicates nominal voltage.

STANDARD APPLICATION

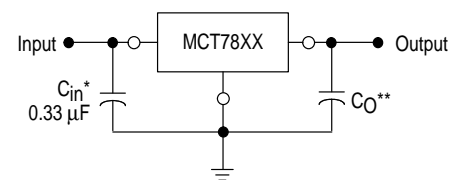

A common ground is required between the input and the output voltages. The input voltage must remain typically 2.0 V above the output voltage even during the low point on the input ripple voltage.

XX, these two digits of the type number indicate nominal voltage.

* C_{in} is required if regulator is located an appreciable distance from power supply filter.

** Some C_O is recommended for stability; it does improve transient response. Values less than 0.1 μF could cause instability.

MCT7800

MAXIMUM RATINGS ($T_A = +25^\circ\text{C}$, unless otherwise noted.)

Rating	Symbol	Value	Unit
Input Voltage	V_I	35	Vdc
Power Dissipation Case 221A	P_D	Internally Limited	W
$T_A = +25^\circ\text{C}$	θ_{JA}	65	$^\circ\text{C/W}$
Thermal Resistance, Junction-to-Ambient	θ_{JC}	5.0	$^\circ\text{C/W}$
Thermal Resistance, Junction-to-Case			
Case 936 (D ² PAK)	P_D	Internally Limited	W
$T_A = +25^\circ\text{C}$	θ_{JA}	70	$^\circ\text{C/W}$
Thermal Resistance, Junction-to-Ambient	θ_{JC}	5.0	$^\circ\text{C/W}$
Thermal Resistance, Junction-to-Case			
Storage Junction Temperature Range	T_{stg}	- 65 to +150	$^\circ\text{C}$
Operating Junction Temperature	T_J	+150	$^\circ\text{C}$

Representative Schematic Diagram

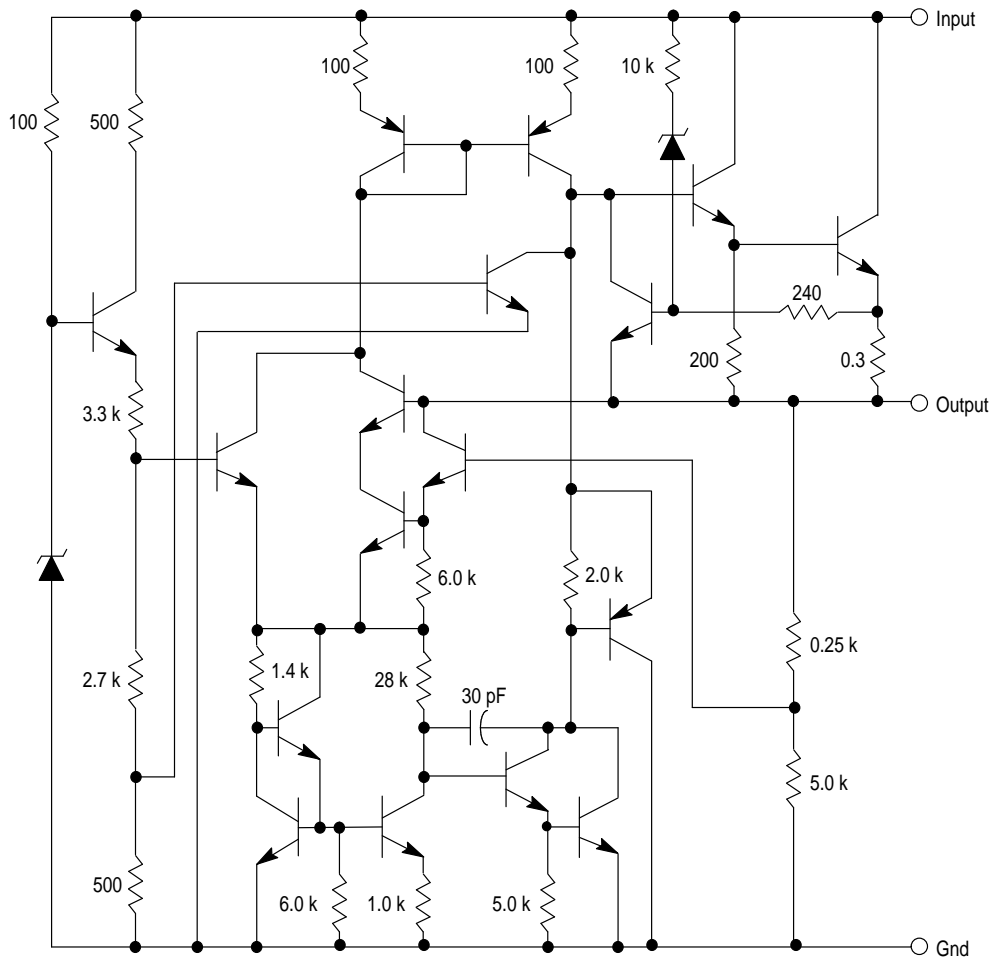

This device contains 19 active transistors.

MCT7800

ELECTRICAL CHARACTERISTICS ($V_{in} = 10\text{ V}$, $I_O = 500\text{ mA}$, $T_J = T_{low}$ to T_{high} [Note 1], unless otherwise noted.)

Characteristics	Symbol	MCT7805B			MCT7805C			Unit
		Min	Typ	Max	Min	Typ	Max	
Output Voltage ($T_J = +25^\circ\text{C}$)	V_O	4.8	5.0	5.2	4.8	5.0	5.2	Vdc
Output Voltage ($5.0\text{ mA} \leq I_O \leq 1.0\text{ A}$, $P_O \leq 15\text{ W}$) 7.0 Vdc $\leq V_{in} \leq 20\text{ Vdc}$ 8.0 Vdc $\leq V_{in} \leq 20\text{ Vdc}$	V_O	— 4.75	— 5.0	— 5.25	4.75 —	5.0 —	5.25 —	Vdc
Line Regulation, $T_J = +25^\circ\text{C}$ (Note 2) 7.0 Vdc $\leq V_{in} \leq 25\text{ Vdc}$ 8.0 Vdc $\leq V_{in} \leq 12\text{ Vdc}$	Regline	— —	7.0 2.0	100 50	— —	7.0 2.0	100 50	mV
Load Regulation, $T_J = +25^\circ\text{C}$ (Note 2) 5.0 mA $\leq V_{in} \leq 1.5\text{ A}$ 250 mA $\leq V_{in} \leq 750\text{ mA}$	Regload	— —	2.0 1.5	100 50	— —	2.0 1.5	100 50	mV
Quiescent Current ($T_J = +25^\circ\text{C}$)	I_B	—	5.5	8.0	—	5.5	8.0	mA
Quiescent Current Change 7.0 Vdc $\leq V_{in} \leq 25\text{ Vdc}$ 8.0 Vdc $\leq V_{in} \leq 25\text{ Vdc}$ 5.0 mA $\leq I_O \leq 1.0\text{ A}$	ΔI_B	— — —	— — —	— 1.3 0.5	— — —	— — —	1.3 — 0.5	mA
Ripple Rejection 8.0 Vdc $\leq V_{in} \leq 18\text{ Vdc}$, $f = 120\text{ Hz}$	RR	—	65	—	—	65	—	dB
Dropout Voltage ($I_O = 1.0\text{ A}$, $T_J = +25^\circ\text{C}$)	$V_I - V_O$	—	2.0	—	—	2.0	—	Vdc
Output Noise Voltage ($T_A = +25^\circ\text{C}$) 10 Hz $\leq f \leq 100\text{ kHz}$	V_n	—	10	—	—	10	—	$\mu\text{V}/V_O$
Output Resistance $f = 1.0\text{ kHz}$	r_O	—	1.3	—	—	1.3	—	$\text{m}\Omega$
Short Circuit Current Limit ($T_A = +25^\circ\text{C}$) $V_{in} = 35\text{ Vdc}$	I_{SC}	—	0.2	—	—	0.2	—	A
Peak Output Current ($T_J = +25^\circ\text{C}$)	I_{max}	—	2.2	—	—	2.2	—	A
Average Temperature Coefficient of Output Voltage	TCV_O	—	0.5	—	—	0.5	—	$\text{mV}/^\circ\text{C}$

ELECTRICAL CHARACTERISTICS ($V_{in} = 11\text{ V}$, $I_O = 500\text{ mA}$, $T_J = T_{low}$ to T_{high} [Note 1], unless otherwise noted.)

Characteristics	Symbol	MCT7806B			MCT7806C			Unit
		Min	Typ	Max	Min	Typ	Max	
Output Voltage ($T_J = +25^\circ\text{C}$)	V_O	5.75	6.0	6.25	5.75	6.0	6.25	Vdc
Output Voltage ($5.0\text{ mA} \leq I_O \leq 1.0\text{ A}$, $P_O \leq 15\text{ W}$) 8.0 Vdc $\leq V_{in} \leq 21\text{ Vdc}$ 9.0 Vdc $\leq V_{in} \leq 21\text{ Vdc}$	V_O	— 5.7	— 6.0	— 6.3	5.7 —	6.0 —	6.3 —	Vdc
Line Regulation, $T_J = +25^\circ\text{C}$ (Note 2) 8.0 Vdc $\leq V_{in} \leq 25\text{ Vdc}$ 9.0 Vdc $\leq V_{in} \leq 13\text{ Vdc}$	Regline	— —	7.0 2.0	120 60	— —	7.0 2.0	120 60	mV
Load Regulation, $T_J = +25^\circ\text{C}$ (Note 2) 5.0 mA $\leq V_{in} \leq 1.5\text{ A}$ 250 mA $\leq V_{in} \leq 750\text{ mA}$	Regload	— —	2.0 1.5	120 60	— —	2.0 1.5	120 60	mV
Quiescent Current ($T_J = +25^\circ\text{C}$)	I_B	—	5.5	8.0	—	5.5	8.0	mA
Quiescent Current Change 8.0 Vdc $\leq V_{in} \leq 25\text{ Vdc}$ 9.0 Vdc $\leq V_{in} \leq 25\text{ Vdc}$ 5.0 mA $\leq I_O \leq 1.0\text{ A}$	ΔI_B	— — —	— — —	— 1.3 0.5	— — —	— — —	1.3 — 0.5	mA
Ripple Rejection 9.0 Vdc $\leq V_{in} \leq 19\text{ Vdc}$, $f = 120\text{ Hz}$	RR	—	65	—	—	65	—	dB

- NOTES:** 1. $T_{low} = 0^\circ\text{C}$ for MCT78XXC, $T_{high} = +125^\circ\text{C}$ for MCT78XXB, C. When the junction temperature exceeds $+125^\circ\text{C}$, internal current limiting will reduce the output current to less than 1.0 A at a $V_I - V_O$ of 15 V or greater. The MCT7800 die will supply more current under the same conditions.
2. Load and line regulation are specified at constant junction temperature. Changes in V_O due to heating effects must be taken into account separately. Pulse testing with low duty cycle is used.

MCT7800

ELECTRICAL CHARACTERISTICS (continued) ($V_{in} = 11\text{ V}$, $I_O = 500\text{ mA}$, $T_J = T_{low}$ to T_{high} [Note 1], unless otherwise noted.)

Characteristics	Symbol	MCT7806B			MCT7806C			Unit
		Min	Typ	Max	Min	Typ	Max	
Dropout Voltage ($I_O = 1.0\text{ A}$, $T_J = +25^\circ\text{C}$)	$V_I - V_O$	—	2.0	—	—	2.0	—	Vdc
Output Noise Voltage ($T_A = +25^\circ\text{C}$) $10\text{ Hz} \leq f \leq 100\text{ kHz}$	V_n	—	10	—	—	10	—	$\mu\text{V}/V_O$
Output Resistance $f = 1.0\text{ kHz}$	r_O	—	1.3	—	—	1.3	—	$\text{m}\Omega$
Short Circuit Current Limit ($T_A = +25^\circ\text{C}$) $V_{in} = 35\text{ Vdc}$	I_{SC}	—	0.2	—	—	0.2	—	A
Peak Output Current ($T_J = +25^\circ\text{C}$)	I_{max}	—	2.2	—	—	2.2	—	A
Average Temperature Coefficient of Output Voltage	TCV_O	—	-0.8	—	—	-0.8	—	$\text{mV}/^\circ\text{C}$

ELECTRICAL CHARACTERISTICS ($V_{in} = 14\text{ V}$, $I_O = 500\text{ mA}$, $T_J = T_{low}$ to T_{high} [Note 1], unless otherwise noted.)

Characteristics	Symbol	MCT7808B			MCT7808C			Unit
		Min	Typ	Max	Min	Typ	Max	
Output Voltage ($T_J = +25^\circ\text{C}$)	V_O	7.7	8.0	8.3	7.7	8.0	8.3	Vdc
Output Voltage ($5.0\text{ mA} \leq I_O \leq 1.0\text{ A}$, $P_O \leq 15\text{ W}$) $10.5\text{ Vdc} \leq V_{in} \leq 23\text{ Vdc}$ $11.5\text{ Vdc} \leq V_{in} \leq 23\text{ Vdc}$	V_O	— 7.6	— 8.0	— 8.4	7.6 —	8.0 —	8.4 —	Vdc
Line Regulation, $T_J = +25^\circ\text{C}$ (Note 2) $10.5\text{ Vdc} \leq V_{in} \leq 25\text{ Vdc}$ $11\text{ Vdc} \leq V_{in} \leq 17\text{ Vdc}$	Reg _{line}	— —	7.0 2.0	160 80	— —	7.0 2.0	160 80	mV
Load Regulation, $T_J = +25^\circ\text{C}$ (Note 2) $5.0\text{ mA} \leq I_O \leq 1.5\text{ A}$ $250\text{ mA} \leq I_O \leq 750\text{ mA}$	Reg _{load}	— —	2.0 1.5	160 80	— —	2.0 1.5	160 80	mV
Quiescent Current ($T_J = +25^\circ\text{C}$)	I_B	—	5.5	8.0	—	5.5	8.0	mA
Quiescent Current Change $10.5\text{ Vdc} \leq V_{in} \leq 25\text{ Vdc}$ $11.5\text{ Vdc} \leq V_{in} \leq 25\text{ Vdc}$ $5.0\text{ mA} \leq I_O \leq 1.0\text{ A}$	ΔI_B	— — —	— — —	— 1.0 0.5	— — —	— — —	1.0 — 0.5	mA
Ripple Rejection $11.5\text{ Vdc} \leq V_{in} \leq 21.5\text{ Vdc}$, $f = 120\text{ Hz}$	RR	—	63	—	—	63	—	dB
Dropout Voltage ($I_O = 1.0\text{ A}$, $T_J = +25^\circ\text{C}$)	$V_I - V_O$	—	2.0	—	—	2.0	—	Vdc
Output Noise Voltage ($T_A = +25^\circ\text{C}$) $10\text{ Hz} \leq f \leq 100\text{ kHz}$	V_n	—	10	—	—	10	—	$\mu\text{V}/V_O$
Output Resistance $f = 1.0\text{ kHz}$	r_O	—	18	—	—	18	—	$\text{m}\Omega$
Short Circuit Current Limit ($T_A = +25^\circ\text{C}$) $V_{in} = 35\text{ Vdc}$	I_{SC}	—	0.2	—	—	0.2	—	A
Peak Output Current ($T_J = +25^\circ\text{C}$)	I_{max}	—	2.2	—	—	2.2	—	A
Average Temperature Coefficient of Output Voltage	TCV_O	—	-0.8	—	—	-0.8	—	$\text{mV}/^\circ\text{C}$

- NOTES:**
- $T_{low} = 0^\circ\text{C}$ for MCT78XXC $T_{high} = +125^\circ\text{C}$ for MCT78XXB, C. When the junction temperature exceeds $+125^\circ\text{C}$, internal current limiting will reduce the output current to less than 1.0 A at a $V_I - V_O$ of 15 V or greater. The MCT7800 die will supply more current under the same conditions.
= -40°C for MCT78XXB
 - Load and line regulation are specified at constant junction temperature. Changes in V_O due to heating effects must be taken into account separately. Pulse testing with low duty cycle is used.

MCT7800

ELECTRICAL CHARACTERISTICS ($V_{in} = 15\text{ V}$, $I_O = 500\text{ mA}$, $T_J = T_{low}$ to T_{high} [Note 1], unless otherwise noted.)

Characteristics	Symbol	MCT7809B			MCT7809C			Unit
		Min	Typ	Max	Min	Typ	Max	
Output Voltage ($T_J = +25^\circ\text{C}$)	V_O	8.65	9.0	9.35	8.65	9.0	9.35	Vdc
Output Voltage ($5.0\text{ mA} \leq I_O \leq 1.0\text{ A}$, $P_O \leq 15\text{ W}$) $11.5\text{ Vdc} \leq V_{in} \leq 24\text{ Vdc}$ $12.5\text{ Vdc} \leq V_{in} \leq 24\text{ Vdc}$	V_O	— 8.55	— 9.0	— 9.45	8.55 —	9.0 —	9.45 —	Vdc
Line Regulation, $T_J = +25^\circ\text{C}$ (Note 2) $11.5\text{ Vdc} \leq V_{in} \leq 26\text{ Vdc}$ $11.5\text{ Vdc} \leq V_{in} \leq 17\text{ Vdc}$	Reg _{line}	— —	8.0 4.0	50 25	— —	8.0 4.0	50 25	mV
Load Regulation, $T_J = +25^\circ\text{C}$ (Note 2) $5.0\text{ mA} \leq I_O \leq 1.5\text{ A}$ $250\text{ mA} \leq I_O \leq 750\text{ mA}$	Reg _{load}	— —	3.0 2.0	50 25	— —	3.0 2.0	50 25	mV
Quiescent Current ($T_J = +25^\circ\text{C}$)	I_B	—	5.5	8.0	—	5.5	8.0	mA
Quiescent Current Change $11.5\text{ Vdc} \leq V_{in} \leq 26\text{ Vdc}$ $12.5\text{ Vdc} \leq V_{in} \leq 26\text{ Vdc}$ $5.0\text{ mA} \leq I_O \leq 1.0\text{ A}$	ΔI_B	— — —	— — —	— 1.0 0.5	— — —	— — —	1.0 — 0.5	mA
Ripple Rejection $11.5\text{ Vdc} \leq V_{in} \leq 21.5\text{ Vdc}$, $f = 120\text{ Hz}$	RR	—	62	—	—	62	—	dB
Dropout Voltage ($I_O = 1.0\text{ A}$, $T_J = +25^\circ\text{C}$)	$V_I - V_O$	—	2.0	—	—	2.0	—	Vdc
Output Noise Voltage ($T_A = +25^\circ\text{C}$) $10\text{ Hz} \leq f \leq 100\text{ kHz}$	V_n	—	10	—	—	10	—	$\mu\text{V}/V_O$
Output Resistance $f = 1.0\text{ kHz}$	r_O	—	18	—	—	18	—	$\text{m}\Omega$
Short Circuit Current Limit ($T_A = +25^\circ\text{C}$) $V_{in} = 35\text{ Vdc}$	I_{SC}	—	0.2	—	—	0.2	—	A
Peak Output Current ($T_J = +25^\circ\text{C}$)	I_{max}	—	2.2	—	—	2.2	—	A
Average Temperature Coefficient of Output Voltage	TCV _O	—	-1.0	—	—	-1.0	—	$\text{mV}/^\circ\text{C}$

ELECTRICAL CHARACTERISTICS ($V_{in} = 19\text{ V}$, $I_O = 500\text{ mA}$, $T_J = T_{low}$ to T_{high} [Note 1], unless otherwise noted.)

Characteristics	Symbol	MCT7812B			MCT7812C			Unit
		Min	Typ	Max	Min	Typ	Max	
Output Voltage ($T_J = +25^\circ\text{C}$)	V_O	11.5	12	12.5	11.5	12	12.5	Vdc
Output Voltage ($5.0\text{ mA} \leq I_O \leq 1.0\text{ A}$, $P_O \leq 15\text{ W}$) $14.5\text{ Vdc} \leq V_{in} \leq 27\text{ Vdc}$ $15.5\text{ Vdc} \leq V_{in} \leq 27\text{ Vdc}$	V_O	— 11.4	— 12	— 12.6	11.4 —	12 —	12.6 —	Vdc
Line Regulation, $T_J = +25^\circ\text{C}$ (Note 2) $14.5\text{ Vdc} \leq V_{in} \leq 30\text{ Vdc}$ $16\text{ Vdc} \leq V_{in} \leq 22\text{ Vdc}$	Reg _{line}	— —	10 5.0	240 120	— —	10 5.0	240 120	mV
Load Regulation, $T_J = +25^\circ\text{C}$ (Note 2) $5.0\text{ mA} \leq I_O \leq 1.5\text{ A}$ $250\text{ mA} \leq I_O \leq 750\text{ mA}$	Reg _{load}	— —	3.0 2.0	240 120	— —	3.0 2.0	240 120	mV
Quiescent Current ($T_J = +25^\circ\text{C}$)	I_B	—	5.5	8.0	—	5.5	8.0	mA
Quiescent Current Change $14.5\text{ Vdc} \leq V_{in} \leq 30\text{ Vdc}$ $15\text{ Vdc} \leq V_{in} \leq 30\text{ Vdc}$ $5.0\text{ mA} \leq I_O \leq 1.0\text{ A}$	ΔI_B	— — —	— — —	— 1.0 0.5	— — —	— — —	1.0 — 0.5	mA

- NOTES:** 1. $T_{low} = 0^\circ\text{C}$ for MCT78XXC $T_{high} = +125^\circ\text{C}$ for MCT78XXB, C. When the junction temperature exceeds $+125^\circ\text{C}$, internal current limiting will reduce the output current to less than 1.0 A at a $V_I - V_O$ of 15 V or greater. The MCT7800 die will supply more current under the same conditions.
= -40°C for MCT78XXB
2. Load and line regulation are specified at constant junction temperature. Changes in V_O due to heating effects must be taken into account separately. Pulse testing with low duty cycle is used.

MCT7800

ELECTRICAL CHARACTERISTICS (continued) ($V_{in} = 19\text{ V}$, $I_O = 500\text{ mA}$, $T_J = T_{low}$ to T_{high} [Note 1], unless otherwise noted.)

Characteristics	Symbol	MCT7812B			MCT7812C			Unit
		Min	Typ	Max	Min	Typ	Max	
Ripple Rejection $15\text{ Vdc} \leq V_{in} \leq 25\text{ Vdc}$, $f = 120\text{ Hz}$	RR	—	62	—	—	62	—	dB
Dropout Voltage ($I_O = 1.0\text{ A}$, $T_J = +25^\circ\text{C}$)	$V_I - V_O$	—	2.0	—	—	2.0	—	Vdc
Output Noise Voltage ($T_A = +25^\circ\text{C}$) $10\text{ Hz} \leq f \leq 100\text{ kHz}$	V_n	—	10	—	—	10	—	$\mu\text{V}/V_O$
Output Resistance $f = 1.0\text{ kHz}$	r_O	—	18	—	—	18	—	$\text{m}\Omega$
Short Circuit Current Limit ($T_A = +25^\circ\text{C}$) $V_{in} = 35\text{ Vdc}$	I_{SC}	—	0.2	—	—	0.2	—	A
Peak Output Current ($T_J = +25^\circ\text{C}$)	I_{max}	—	2.2	—	—	2.2	—	A
Average Temperature Coefficient of Output Voltage	TCV_O	—	-1.0	—	—	-1.0	—	$\text{mV}/^\circ\text{C}$

ELECTRICAL CHARACTERISTICS ($V_{in} = 23\text{ V}$, $I_O = 500\text{ mA}$, $T_J = T_{low}$ to T_{high} [Note 1], unless otherwise noted.)

Characteristics	Symbol	MCT7815B			MCT7815C			Unit
		Min	Typ	Max	Min	Typ	Max	
Output Voltage ($T_J = +25^\circ\text{C}$)	V_O	14.4	15	15.6	14.4	15	15.6	Vdc
Output Voltage ($5.0\text{ mA} \leq I_O \leq 1.0\text{ A}$, $P_O \leq 15\text{ W}$) $17.5\text{ Vdc} \leq V_{in} \leq 30\text{ Vdc}$ $18.5\text{ Vdc} \leq V_{in} \leq 30\text{ Vdc}$	V_O	— 14.25	— 15	— 15.75	14.25 —	15 —	15.75 —	Vdc
Line Regulation, $T_J = +25^\circ\text{C}$ (Note 2) $17.5\text{ Vdc} \leq V_{in} \leq 30\text{ Vdc}$ $20\text{ Vdc} \leq V_{in} \leq 26\text{ Vdc}$	Regline	— —	11 5.0	300 150	— —	11 5.0	300 150	mV
Load Regulation, $T_J = +25^\circ\text{C}$ (Note 2) $5.0\text{ mA} \leq V_{in} \leq 1.5\text{ A}$ $250\text{ mA} \leq V_{in} \leq 750\text{ mA}$	Regload	— —	3.0 2.0	300 150	— —	3.0 2.0	300 150	mV
Quiescent Current ($T_J = +25^\circ\text{C}$)	I_B	—	5.5	8.0	—	5.5	8.0	mA
Quiescent Current Change $17.5\text{ Vdc} \leq V_{in} \leq 30\text{ Vdc}$ $18.5\text{ Vdc} \leq V_{in} \leq 30\text{ Vdc}$ $5.0\text{ mA} \leq I_O \leq 1.0\text{ A}$	ΔI_B	— — —	— — —	— 1.0 0.5	— — —	— — —	1.0 — 0.5	mA
Ripple Rejection $18.5\text{ Vdc} \leq V_{in} \leq 28.5\text{ Vdc}$, $f = 120\text{ Hz}$	RR	—	60	—	—	60	—	dB
Dropout Voltage ($I_O = 1.0\text{ A}$, $T_J = +25^\circ\text{C}$)	$V_I - V_O$	—	2.0	—	—	2.0	—	Vdc
Output Noise Voltage ($T_A = +25^\circ\text{C}$) $10\text{ Hz} \leq f \leq 100\text{ kHz}$	V_n	—	10	—	—	10	—	$\mu\text{V}/V_O$
Output Resistance $f = 1.0\text{ kHz}$	r_O	—	19	—	—	19	—	$\text{m}\Omega$
Short Circuit Current Limit ($T_A = +25^\circ\text{C}$) $V_{in} = 35\text{ Vdc}$	I_{SC}	—	0.2	—	—	0.2	—	A
Peak Output Current ($T_J = +25^\circ\text{C}$)	I_{max}	—	2.2	—	—	2.2	—	A
Average Temperature Coefficient of Output Voltage	TCV_O	—	-1.0	—	—	-1.0	—	$\text{mV}/^\circ\text{C}$

- NOTES:** 1. $T_{low} = 0^\circ\text{C}$ for MCT78XXC $T_{high} = +125^\circ\text{C}$ for MCT78XXB, C. When the junction temperature exceeds $+125^\circ\text{C}$, internal current limiting will reduce the output current to less than 1.0 A at a $V_I - V_O$ of 15 V or greater. The MCT7800 die will supply more current under the same conditions.
2. Load and line regulation are specified at constant junction temperature. Changes in V_O due to heating effects must be taken into account separately. Pulse testing with low duty cycle is used.

MCT7800

ELECTRICAL CHARACTERISTICS ($V_{in} = 27\text{ V}$, $I_O = 500\text{ mA}$, $T_J = T_{low}$ to T_{high} [Note 1], unless otherwise noted.)

Characteristics	Symbol	MCT7818B			MCT7818C			Unit
		Min	Typ	Max	Min	Typ	Max	
Output Voltage ($T_J = +25^\circ\text{C}$)	V_O	17.3	18	18.7	17.3	18	18.7	Vdc
Output Voltage ($5.0\text{ mA} \leq I_O \leq 1.0\text{ A}$, $P_O \leq 15\text{ W}$) $21\text{ Vdc} \leq V_{in} \leq 33\text{ Vdc}$ $22\text{ Vdc} \leq V_{in} \leq 33\text{ Vdc}$	V_O	— 17.1	— 18	— 18.9	17.1 —	18 —	18.9 —	Vdc
Line Regulation, $T_J = +25^\circ\text{C}$ (Note 2) $21\text{ Vdc} \leq V_{in} \leq 33\text{ Vdc}$ $24\text{ Vdc} \leq V_{in} \leq 30\text{ Vdc}$	Regline	— —	11 5.0	360 180	— —	11 5.0	360 180	mV
Load Regulation, $T_J = +25^\circ\text{C}$ (Note 2) $5.0\text{ mA} \leq V_{in} \leq 1.5\text{ A}$ $250\text{ mA} \leq V_{in} \leq 750\text{ mA}$	Regload	— —	4.0 3.0	360 180	— —	4.0 3.0	360 180	mV
Quiescent Current ($T_J = +25^\circ\text{C}$)	I_B	—	5.5	8.0	—	5.5	8.0	mA
Quiescent Current Change $21\text{ Vdc} \leq V_{in} \leq 33\text{ Vdc}$ $22\text{ Vdc} \leq V_{in} \leq 33\text{ Vdc}$ $5.0\text{ mA} \leq I_O \leq 1.0\text{ A}$	ΔI_B	— — —	— — —	— 1.0 0.5	— — —	— — —	1.0 — 0.5	mA
Ripple Rejection $22\text{ Vdc} \leq V_{in} \leq 32\text{ Vdc}$, $f = 120\text{ Hz}$	RR	—	59	—	—	59	—	dB
Dropout Voltage ($I_O = 1.0\text{ A}$, $T_J = +25^\circ\text{C}$)	$V_{I1} - V_O$	—	2.0	—	—	2.0	—	Vdc
Output Noise Voltage ($T_A = +25^\circ\text{C}$) $10\text{ Hz} \leq f \leq 100\text{ kHz}$	V_n	—	10	—	—	10	—	$\mu\text{V}/V_O$
Output Resistance $f = 1.0\text{ kHz}$	r_O	—	19	—	—	19	—	$\text{m}\Omega$
Short Circuit Current Limit ($T_A = +25^\circ\text{C}$) $V_{in} = 35\text{ Vdc}$	I_{SC}	—	0.2	—	—	0.2	—	A
Peak Output Current ($T_J = +25^\circ\text{C}$)	I_{max}	—	2.2	—	—	2.2	—	A
Average Temperature Coefficient of Output Voltage	TCV_O	—	-1.0	—	—	-1.0	—	$\text{mV}/^\circ\text{C}$

ELECTRICAL CHARACTERISTICS ($V_{in} = 33\text{ V}$, $I_O = 500\text{ mA}$, $T_J = T_{low}$ to T_{high} [Note 1], unless otherwise noted.)

Characteristics	Symbol	MCT7824B			MCT7824C			Unit
		Min	Typ	Max	Min	Typ	Max	
Output Voltage ($T_J = +25^\circ\text{C}$)	V_O	23	24	25	23	24	25	Vdc
Output Voltage ($5.0\text{ mA} \leq I_O \leq 1.0\text{ A}$, $P_O \leq 15\text{ W}$) $27\text{ Vdc} \leq V_{in} \leq 38\text{ Vdc}$ $28\text{ Vdc} \leq V_{in} \leq 38\text{ Vdc}$	V_O	— 22.8	— 24	— 25.2	22.8 —	24 —	25.2 —	Vdc
Line Regulation, $T_J = +25^\circ\text{C}$ (Note 2) $27\text{ Vdc} \leq V_{in} \leq 38\text{ Vdc}$ $30\text{ Vdc} \leq V_{in} \leq 36\text{ Vdc}$	Regline	— —	12 6.0	480 240	— —	12 6.0	480 240	mV
Load Regulation, $T_J = +25^\circ\text{C}$ (Note 2) $5.0\text{ mA} \leq I_O \leq 1.5\text{ A}$ $250\text{ mA} \leq I_O \leq 750\text{ mA}$	Regload	— —	5.0 4.0	480 240	— —	5.0 4.0	480 240	mV
Quiescent Current ($T_J = +25^\circ\text{C}$)	I_B	—	5.5	8.0	—	5.5	8.0	mA
Quiescent Current Change $27\text{ Vdc} \leq V_{in} \leq 38\text{ Vdc}$ $28\text{ Vdc} \leq V_{in} \leq 38\text{ Vdc}$ $5.0\text{ mA} \leq I_O \leq 1.0\text{ A}$	ΔI_B	— — —	— — —	— 1.0 0.5	— — —	— — —	1.0 — 0.5	mA
Ripple Rejection $28\text{ Vdc} \leq V_{in} \leq 38\text{ Vdc}$, $f = 120\text{ Hz}$	RR	—	56	—	—	56	—	dB
Dropout Voltage ($I_O = 1.0\text{ A}$, $T_J = +25^\circ\text{C}$)	$V_I - V_O$	—	2.0	—	—	2.0	—	Vdc
Output Noise Voltage ($T_A = +25^\circ\text{C}$) $10\text{ Hz} \leq f \leq 100\text{ kHz}$	V_n	—	10	—	—	10	—	$\mu\text{V}/V_O$
Output Resistance $f = 1.0\text{ kHz}$	r_O	—	20	—	—	20	—	$\text{m}\Omega$
Short Circuit Current Limit ($T_A = +25^\circ\text{C}$) $V_{in} = 35\text{ Vdc}$	I_{SC}	—	0.2	—	—	0.2	—	A
Peak Output Current ($T_J = +25^\circ\text{C}$)	I_{max}	—	2.2	—	—	2.2	—	A
Average Temperature Coefficient of Output Voltage	TCV_O	—	-1.5	—	—	-1.5	—	$\text{mV}/^\circ\text{C}$

- NOTES:** 1. $T_{low} = 0^\circ\text{C}$ for MCT78XXC $T_{high} = +125^\circ\text{C}$ for MCT78XXB, C. When the junction temperature exceeds $+125^\circ\text{C}$, internal current limiting will reduce the output current to less than 1.0 A at a $V_I - V_O$ of 15 V or greater. The MCT7800 die will supply more current under the same conditions.
2. Load and line regulation are specified at constant junction temperature. Changes in V_O due to heating effects must be taken into account separately. Pulse testing with low duty cycle is used.

Figure 1. Peak Output Current as a Function of Input-Output Differential Voltage

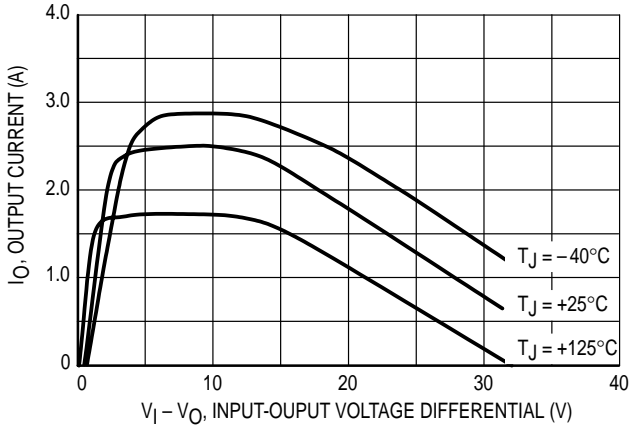

Figure 2. Ripple Rejection as a Function of Output Voltages (MCT78XXC)

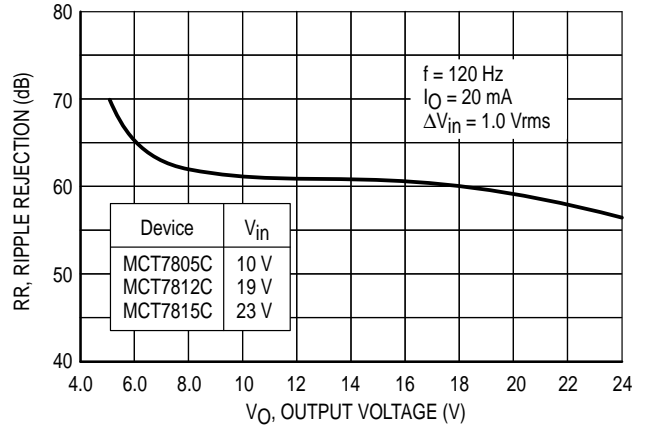

Figure 3. Ripple Rejection as a Function of Frequency (MCT78XXC)

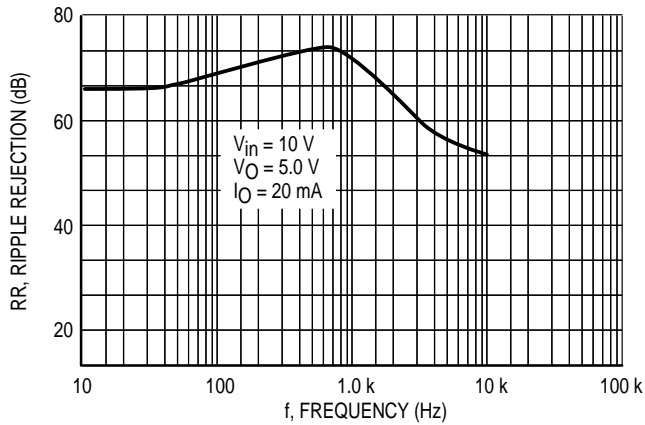

Figure 4. Output Impedance as a Function of Output Voltage (MCT78XXC)

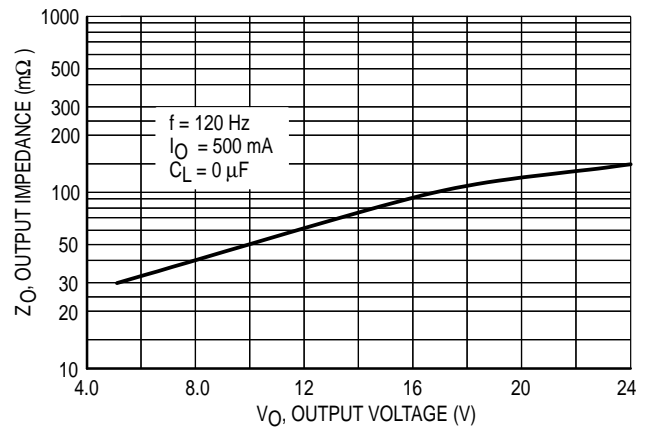
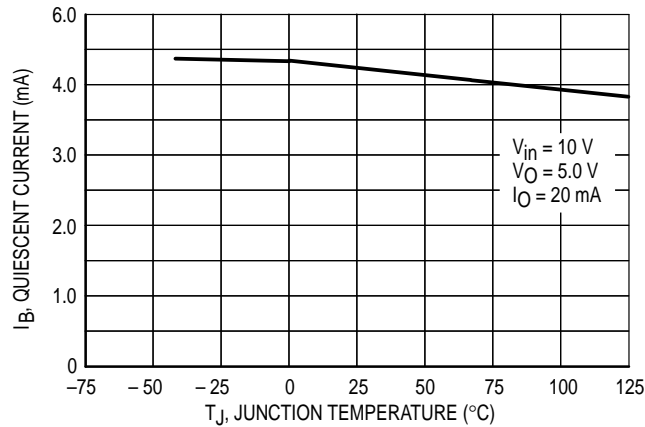

Figure 5. Quiescent Current as a Function of Temperature



APPLICATIONS INFORMATION

Design Considerations

The MCT7800 Series of fixed voltage regulators are designed with thermal overload protection that shuts down the circuit when subjected to an excessive power overload condition, internal short circuit protection that limits the maximum current the circuit will pass, and output transistor safe-area compensation that reduces the output short circuit current as the voltage across the pass transistor is increased.

In many low current applications, compensation capacitors are not required. However, it is recommended that the regulator input be bypassed with a capacitor if the regulator is connected to the power supply filter with long wire lengths, or

if the output load capacitance is large. An input bypass capacitor should be selected to provide good high frequency characteristics to insure stable operation under all load conditions. A 0.33 μF or larger tantalum, mylar, or other capacitor having low internal impedance at high frequencies, should be chosen. The bypass capacitor should be mounted with the shortest possible leads directly across the regulators' input terminals. Normally, good construction techniques should be used to minimize ground loops and lead resistance drops since the regulator has no external sense lead.

Figure 6. Worst Case Power Dissipation versus Ambient Temperature (Case 221A)

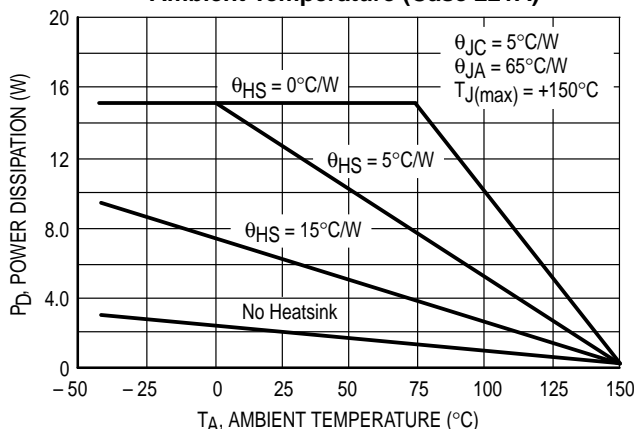

Figure 7. Input Output Differential as a Function of Junction Temperature

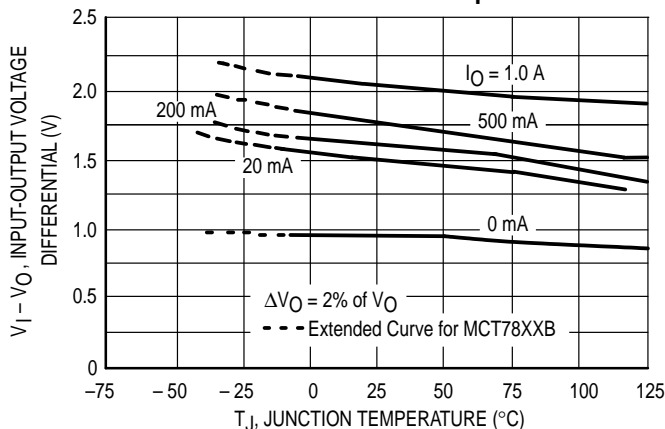
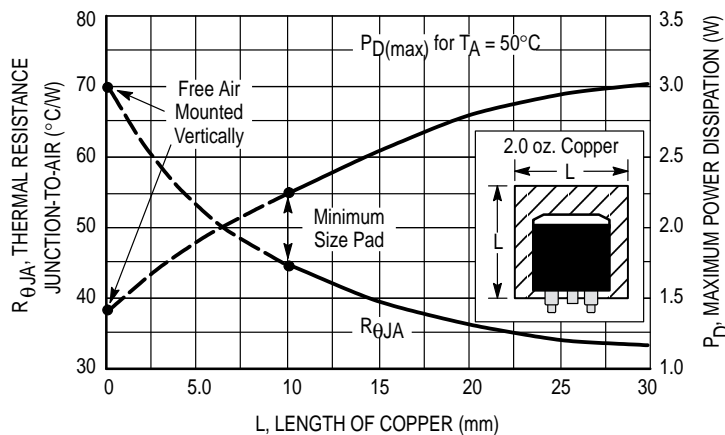

Figure 8. D²PAK Thermal Resistance and Maximum Power Dissipation versus P.C.B. Copper Length



DEFINITIONS

Line Regulation — The change in output voltage for a change in the input voltage. The measurement is made under conditions of low dissipation or by using pulse techniques such that the average chip temperature is not significantly affected.

Load Regulation — The change in output voltage for a change in load current at constant chip temperature.

Maximum Power Dissipation — The maximum total device dissipation for which the regulator will operate within specifications.

Quiescent Current — That part of the input current that is not delivered to the load.

Output Noise Voltage — The rms AC voltage at the output, with constant load and no input ripple, measured over a specified frequency range.

Long Term Stability — Output voltage stability under accelerated life test conditions with the maximum rated voltage listed in the devices' electrical characteristics and maximum power dissipation.

MCT7800

OUTLINE DIMENSIONS

T SUFFIX PLASTIC PACKAGE CASE 221A-06

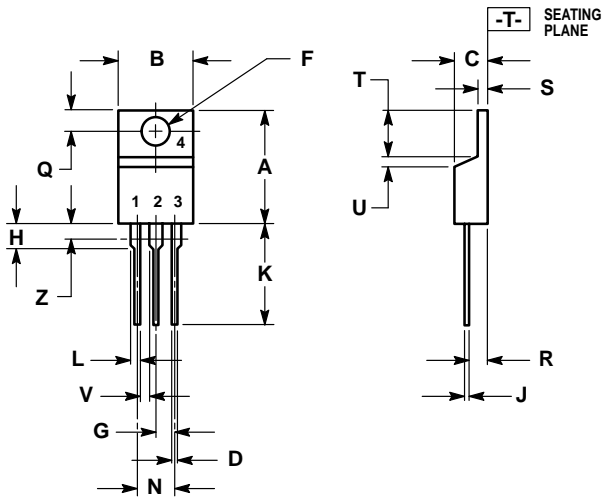

NOTES:

1. DIMENSIONING AND TOLERANCING PER ANSI Y14.5M, 1982.
2. CONTROLLING DIMENSION: INCH.
3. DIM Z DEFINES A ZONE WHERE ALL BODY AND LEAD IRREGULARITIES ARE ALLOWED.

DIM	INCHES		MILLIMETERS	
	MIN	MAX	MIN	MAX
A	0.570	0.620	14.48	15.75
B	0.380	0.405	9.66	10.28
C	0.160	0.190	4.07	4.82
D	0.025	0.035	0.64	0.88
F	0.142	0.147	3.61	3.73
G	0.095	0.105	2.42	2.66
H	0.110	0.155	2.80	3.93
J	0.018	0.025	0.46	0.64
K	0.500	0.562	12.70	14.27
L	0.045	0.060	1.15	1.52
N	0.190	0.210	4.83	5.33
Q	0.100	0.120	2.54	3.04
R	0.080	0.110	2.04	2.79
S	0.045	0.055	1.15	1.39
T	0.235	0.255	5.97	6.47
U	0.000	0.050	0.00	1.27
V	0.045	—	1.15	—
Z	—	0.080	—	2.04

D2T SUFFIX PLASTIC PACKAGE CASE 936-03 (D²PAK)

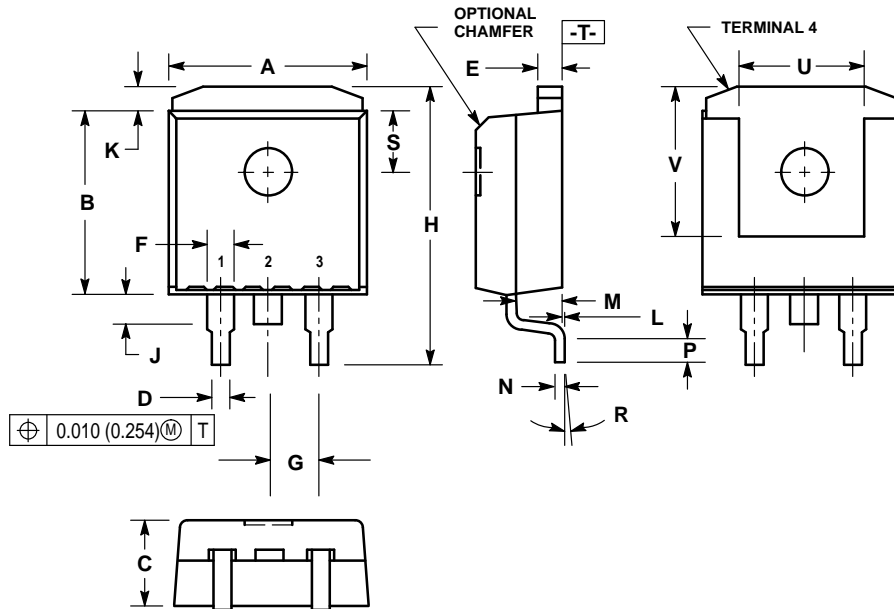

NOTES:

1. DIMENSIONING AND TOLERANCING PER ANSI Y14.5M, 1982.
2. CONTROLLING DIMENSION: INCH.
3. TAB CONTOUR OPTIONAL WITHIN DIMENSIONS A AND K.
4. DIMENSIONS U AND V ESTABLISH A MINIMUM MOUNTING SURFACE FOR TERMINAL 4.
5. DIMENSIONS A AND B DO NOT INCLUDE MOLD FLASH OR GATE PROTRUSIONS. MOLD FLASH AND GATE PROTRUSIONS NOT TO EXCEED 0.025 (0.635) MAXIMUM.

DIM	INCHES		MILLIMETERS	
	MIN	MAX	MIN	MAX
A	0.386	0.403	9.804	10.236
B	0.356	0.368	9.042	9.347
C	0.170	0.180	4.318	4.572
D	0.026	0.036	0.660	0.914
E	0.045	0.055	1.143	1.397
F	0.051	REF	1.295	REF
G	0.100	BSC	2.540	BSC
H	0.539	0.579	13.691	14.707
J	0.125	MAX	3.175	MAX
K	0.050	REF	1.270	REF
L	0.000	0.010	0.000	0.254
M	0.088	0.102	2.235	2.591
N	0.018	0.026	0.457	0.660
P	0.058	0.078	1.473	1.981
R	5°	REF	5°	REF
S	0.116	REF	2.946	REF
U	0.200	MIN	5.080	MIN
V	0.250	MIN	6.350	MIN

MCT7800

NOTES

MCT7800

Motorola reserves the right to make changes without further notice to any products herein. Motorola makes no warranty, representation or guarantee regarding the suitability of its products for any particular purpose, nor does Motorola assume any liability arising out of the application or use of any product or circuit, and specifically disclaims any and all liability, including without limitation consequential or incidental damages. "Typical" parameters can and do vary in different applications. All operating parameters, including "Typicals" must be validated for each customer application by customer's technical experts. Motorola does not convey any license under its patent rights nor the rights of others. Motorola products are not designed, intended, or authorized for use as components in systems intended for surgical implant into the body, or other applications intended to support or sustain life, or for any other application in which the failure of the Motorola product could create a situation where personal injury or death may occur. Should Buyer purchase or use Motorola products for any such unintended or unauthorized application, Buyer shall indemnify and hold Motorola and its officers, employees, subsidiaries, affiliates, and distributors harmless against all claims, costs, damages, and expenses, and reasonable attorney fees arising out of, directly or indirectly, any claim of personal injury or death associated with such unintended or unauthorized use, even if such claim alleges that Motorola was negligent regarding the design or manufacture of the part. Motorola and  are registered trademarks of Motorola, Inc. Motorola, Inc. is an Equal Opportunity/Affirmative Action Employer.

Literature Distribution Centers:

USA: Motorola Literature Distribution; P.O. Box 20912; Phoenix, Arizona 85036.

EUROPE: Motorola Ltd.; European Literature Centre; 88 Tanners Drive, Blakelands, Milton Keynes, MK14 5BP, England.

JAPAN: Nippon Motorola Ltd.; 4-32-1, Nishi-Gotanda, Shinagawa-ku, Tokyo 141, Japan.

ASIA PACIFIC: Motorola Semiconductors H.K. Ltd.; Silicon Harbour Center, No. 2 Dai King Street, Tai Po Industrial Estate, Tai Po, N.T., Hong Kong.

