

HEXFET® TRANSISTORS IRFZ20

IRFZ22

**N-Channel
50 Volt
Power MOSFETs**

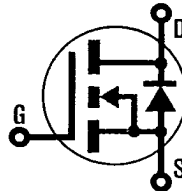

50 Volt, 0.1 Ohm HEXFET TO-220AB Plastic Package

The HEXFET technology has expanded its product base to serve the low voltage, very low $R_{DS(on)}$ MOSFET transistor requirements. International Rectifier's highly efficient geometry and unique processing of the HEXFET have been combined to create the lowest on resistance per device performance. In addition to this feature all HEXFETs have documented reliability and parts per million quality!

The HEXFET transistors also offer all of the well established advantages of MOSFETs such as voltage control, very fast switching, ease of paralleling, and temperature stability of the electrical parameters.

They are well suited for applications such as switching power supplies, motor controls, inverters, choppers, audio amplifiers, high energy pulse circuits, and in systems that are operated from low voltage batteries, such as automotive, portable equipment, etc.

Product Summary

Part Number	V_{DS}	$R_{DS(on)}$	I_D
IRFZ20	50V	0.10 Ω	15A
IRFZ22	50V	0.12 Ω	14A

Features:

- Extremely Low $R_{DS(on)}$
- Compact Plastic Package
- Fast Switching
- Low Drive Current
- Ease of Paralleling
- Excellent Temperature Stability
- Parts Per Million Quality

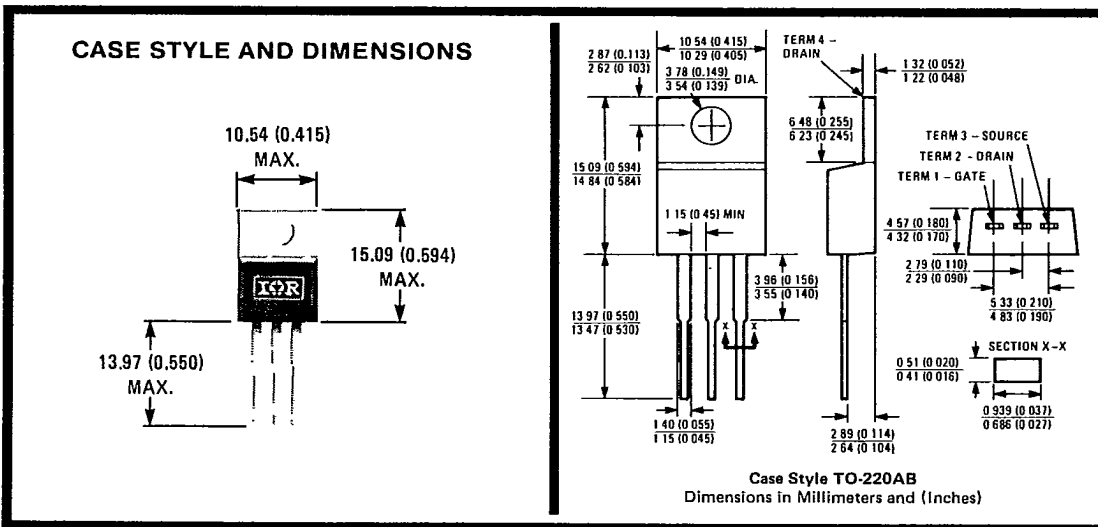

IRFZ20, IRFZ22 Devices

Absolute Maximum Ratings

Parameter	IRFZ20	IRFZ22	Units
V _{DS} Drain - Source Voltage (1)	50	50	V
V _{DGR} Drain - Gate Voltage (R _{GS} = 20 kΩ) (1)	50	50	V
I _D @ T _C = 25°C Continuous Drain Current	15	14	A
I _D @ T _C = 100°C Continuous Drain Current	10	9.0	A
I _{DM} Pulsed Drain Current (2)	60	56	A
V _{GS} Gate - Source Voltage	±20		V
P _D @ T _C = 25°C Max. Power Dissipation	40 (See Fig. 14)		W
Linear Derating Factor	0.32 (See Fig. 14)		W/K (3)
I _{LM} Inductive Current, Clamped	(See Fig. 15 and 16) L = 100μH		A
T _J Operating Junction and Storage Temperature Range	-55 to 150		°C
T _{stg} Lead Temperature	300 (0.063 in. (1.6mm) from case for 10s)		°C

Electrical Characteristics @ T_C = 25°C (Unless Otherwise Specified)

Parameter	Type	Min.	Typ.	Max.	Units	Test Conditions
BV _{DSS} Drain - Source Breakdown Voltage	IRFZ20	50	—	—	V	V _{GS} = 0V I _D = 250 μA
	IRFZ22	50	—	—	V	
V _{GS(th)} Gate Threshold Voltage	ALL	2.0	—	4.0	V	V _{DS} = V _{GS} , I _D = 250 μA
I _{GSS} Gate-Source Leakage Forward	ALL	—	—	500	nA	V _{GS} = 20V
I _{GSS} Gate-Source Leakage Reverse	ALL	—	—	-500	nA	V _{GS} = -20V
I _{DSS} Zero Gate Voltage Drain Current	ALL	—	—	250	μA	V _{DS} = Max. Rating, V _{GS} = 0V
				1000	μA	V _{DS} = Max. Rating × 0.8, V _{GS} = 0V, T _C = 125°C
I _{D(on)} On-State Drain Current (4)	IRFZ20	15	—	—	A	V _{DS} > I _{D(on)} × R _{DS(on)max.} , V _{GS} = 10V
	IRFZ22	14	—	—	A	
R _{DS(on)} Static Drain-Source On-State Resistance (4)	IRFZ20	—	0.080	0.100	Ω	V _{GS} = 10V, I _D = 9.0A
	IRFZ22	—	0.110	0.120	Ω	
g _{fs} Forward Transconductance (4)	ALL	5.0	6.0	—	S(D)	V _{DS} > I _{D(on)} × R _{DS(on)max.} , I _D = 9.0A
C _{iss} Input Capacitance	ALL	—	560	860	pF	V _{GS} = 0V, V _{DS} = 25V, f = 1.0 MHz
C _{oss} Output Capacitance	ALL	—	250	350	pF	See Fig. 10
C _{rss} Reverse Transfer Capacitance	ALL	—	60	100	pF	
t _{d(on)} Turn-On Delay Time	ALL	—	15	30	ns	V _{DD} ≈ 25V, I _D = 9.0A, Z ₀ = 500
t _r Rise Time	ALL	—	45	90	ns	See Fig. 17
t _{d(off)} Turn-Off Delay Time	ALL	—	20	40	ns	(MOSFET switching times are essentially independent of operating temperature.)
t _f Fall Time	ALL	—	15	30	ns	
Q _g Total Gate Charge (Gate-Source Plus Gate-Drain)	ALL	—	12	17	nC	V _{GS} = 10V, I _D = 20A, V _{DS} = 0.8 Max. Rating. See Fig. 18 for test circuit. (Gate charge is essentially independent of operating temperature.)
Q _{gs} Gate-Source Charge	ALL	—	9.0	—	nC	
Q _{gd} Gate-Drain ("Miller") Charge	ALL	—	3.0	—	nC	
L _D Internal Drain Inductance	ALL	—	3.5	—	nH	Measured from the contact screw on tab to center of dia.
			4.5	—	nH	Measured from the drain lead, 6mm (0.25 in.) from package to center of dia.
L _S Internal Source Inductance	ALL	—	7.5	—	nH	Measured from the source lead, 6mm (0.25 in.) from package to source bonding pad.

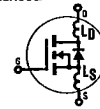

Thermal Resistance

R _{thJC} Junction-to-Case	ALL	—	—	3.12	K/W (5)	
R _{thCS} Case-to-Sink	ALL	—	1.0	—	K/W (5)	Mounting surface flat, smooth, and greased.
R _{thJA} Junction-to-Ambient	ALL	—	—	80	K/W (5)	Typical socket mount

Source-Drain Diode Ratings and Characteristics

I_S	Continuous Source Current (Body Diode)	IRFZ20	—	—	15	A	Modified MOSFET symbol showing the integral reverse P-N junction rectifier.
		IRFZ22	—	—	14	A	
I_{SM}	Pulse Source Current (Body Diode) ③	IRFZ20	—	—	60	A	
		IRFZ22	—	—	56	A	
V_{SD}	Diode Forward Voltage ②	IRFZ20	—	—	1.6	V	$T_C = 25^\circ\text{C}, I_S = 15\text{A}, V_{GS} = 0\text{V}$
		IRFZ22	—	—	1.4	V	$T_C = 25^\circ\text{C}, I_S = 14\text{A}, V_{GS} = 0\text{V}$
t_{rr}	Reverse Recovery Time	ALL	—	100	—	ns	$T_J = 150^\circ\text{C}, I_F = 15\text{A}, dI_F/dt = 100\text{A}/\mu\text{s}$
Q_{RR}	Reverse Recovered Charge	ALL	—	0.4	—	μC	$T_J = 150^\circ\text{C}, I_F = 15\text{A}, dI_F/dt = 100\text{A}/\mu\text{s}$
t_{on}	Forward Turn-on Time	ALL	Intrinsic turn-on time is negligible. Turn-on speed is substantially controlled by $L_S + L_D$.				

① $T_J = 25^\circ\text{C}$ to 150°C .

② Pulse Test: Pulse width $\leq 300\mu\text{s}$, Duty Cycle $\leq 2\%$.

③ Repetitive Rating: Pulse width limited by max. junction temperature. See Transient Thermal Impedance Curve (Fig. 5).

④ $K/W = ^\circ\text{C}/\text{W}$
 $W/K = \text{W}/^\circ\text{C}$

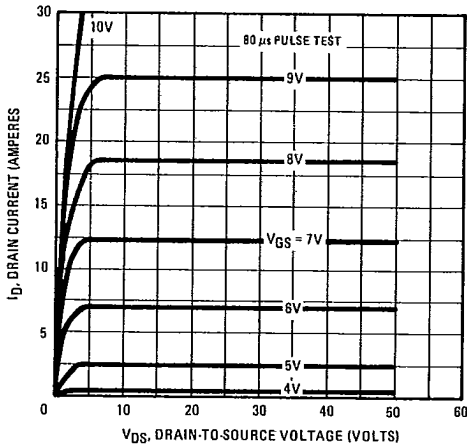

Fig. 1 — Typical Output Characteristics

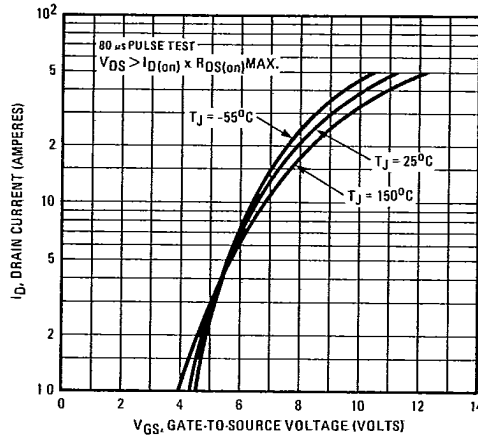

Fig. 2 — Typical Transfer Characteristics

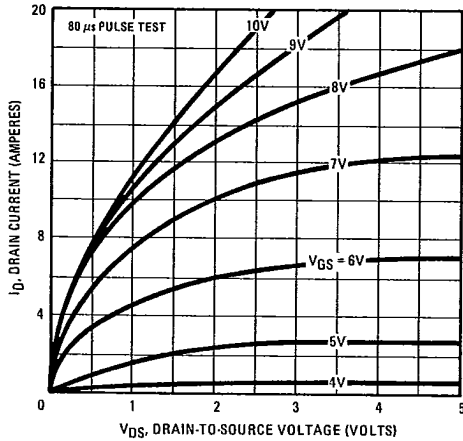

Fig. 3 — Typical Saturation Characteristics

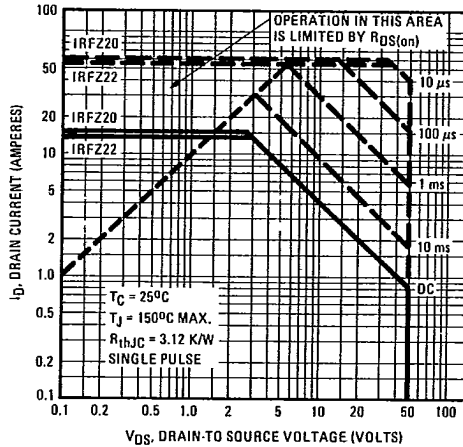

Fig. 4 — Maximum Safe Operating Area

IRFZ20, IRFZ22 Devices

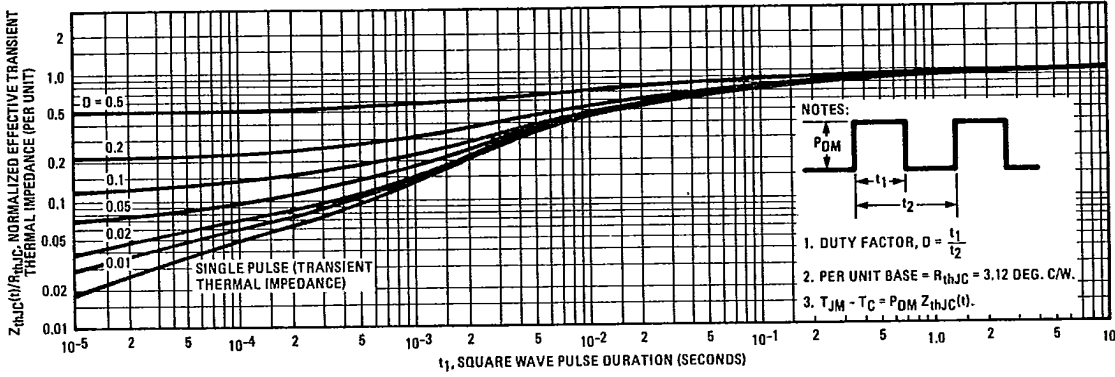

Fig. 5 – Maximum Effective Transient Thermal Impedance, Junction-to-Case Vs. Pulse Duration

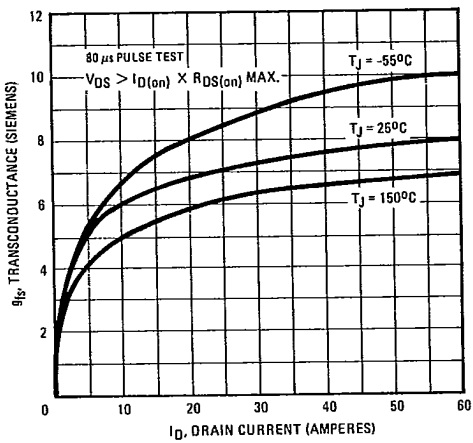

Fig. 6 – Typical Transconductance Vs. Drain Current

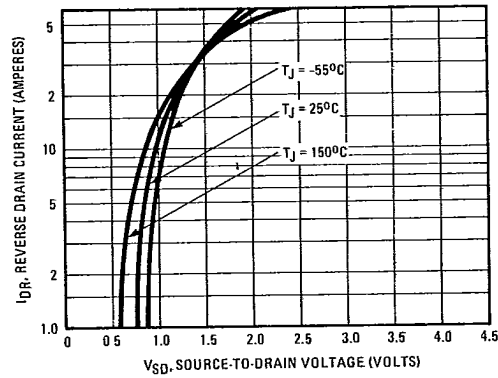

Fig. 7 – Typical Source-Drain Diode Forward Voltage

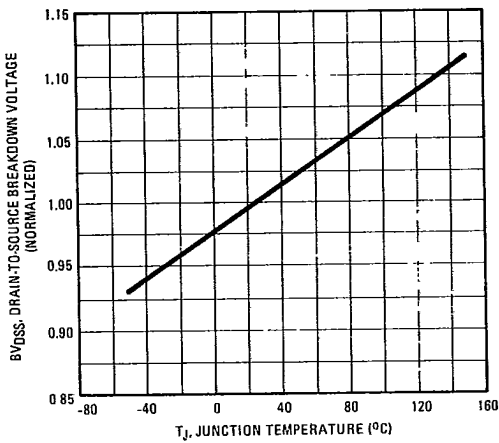

Fig. 8 – Breakdown Voltage Vs. Temperature

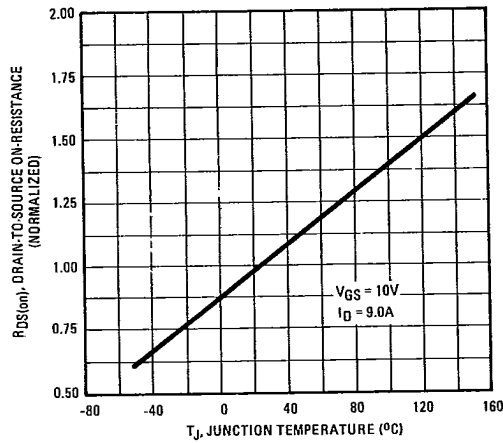

Fig. 9 – Normalized On-Resistance Vs. Temperature

IRFZ20, IRFZ22 Devices

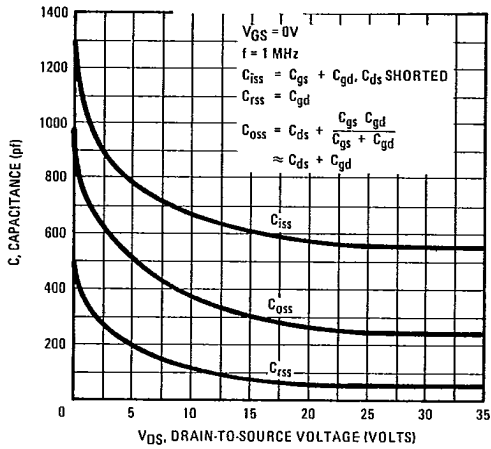

Fig. 10 – Typical Capacitance Vs. Drain-to-Source Voltage

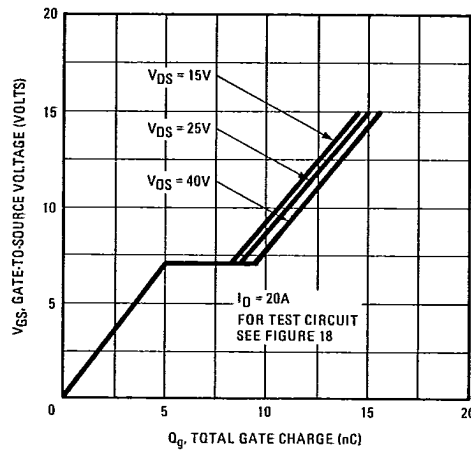

Fig. 11 – Typical Gate Charge Vs. Gate-to-Source Voltage

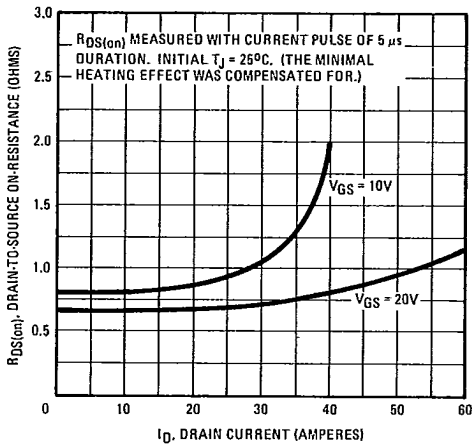

Fig. 12 – Typical On-Resistance Vs. Drain Current

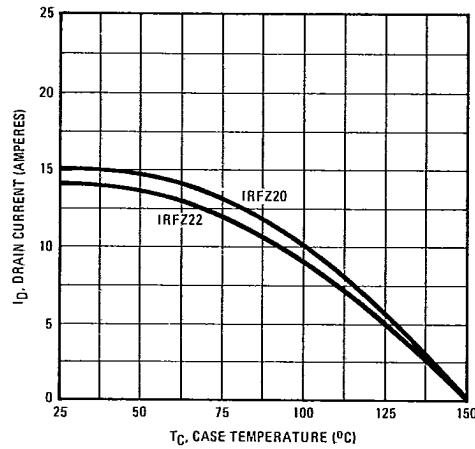

Fig. 13 – Maximum Drain Current Vs. Case Temperature

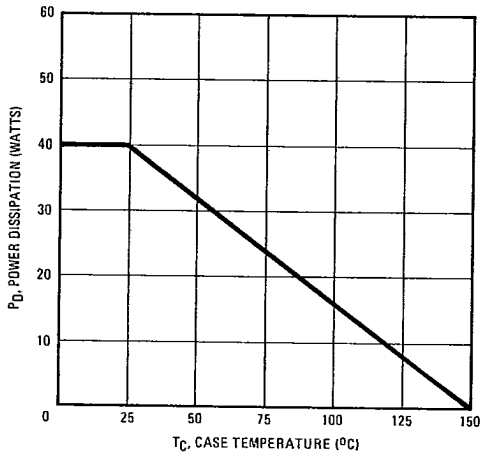

Fig. 14 – Power Vs. Temperature Derating Curve

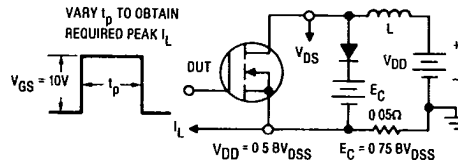

Fig. 15 – Clamped Inductive Test Circuit

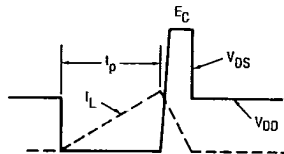

Fig. 16 – Clamped Inductive Waveforms

IRFZ20, IRFZ22 Devices

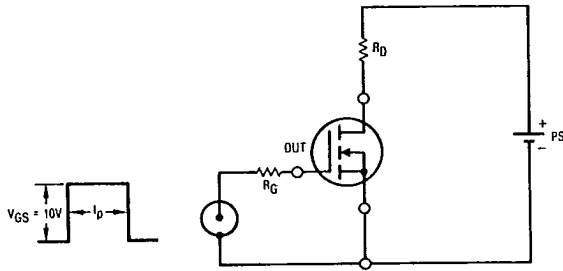

Fig. 17 — Switching Time Test Circuit

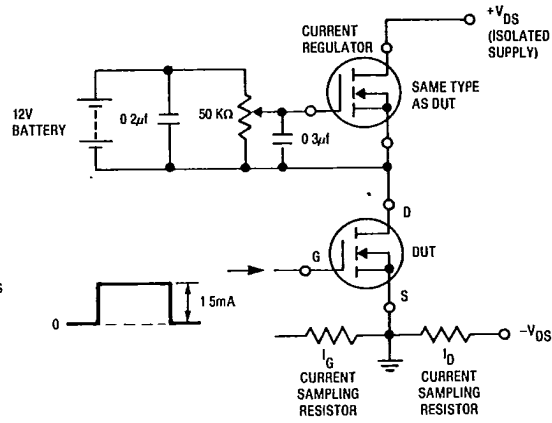
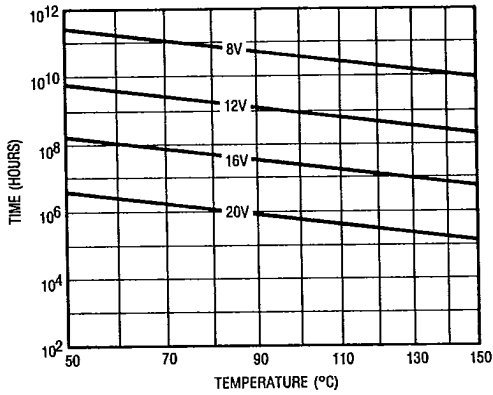
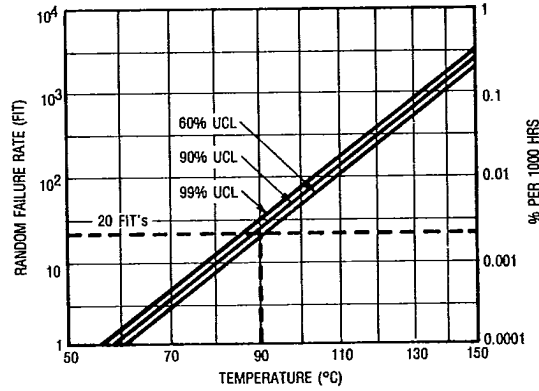

Fig. 18 — Gate Charge Test Circuit



*Fig. 19 — Typical Time to Accumulated 1% Failure



*Fig. 20 — Typical High Temperature Reverse Bias (HTRB) Failure Rate

*The data shown is correct as of April 15, 1987. This information is updated on a quarterly basis; for the latest reliability data, please contact your local IR field office.