

Type 112 is hermetically sealed capacitors in metal case, designed for high reliability.

FEATURES

1. Type 112 is smaller and larger capacitance compared with Type 111.
2. The type is hermetically sealed capacitors in metal case, designed for excellent stability.
3. Designed for high reliability.
4. Available for capacitance tolerance code "J"(±5%).

RATING

Item	Rating
Category temperature range (Operating temperature)	-55 ~ +125°C
Rated Temperature (Maximum operating temperature for DC rated Voltage)	+85°C ⁽¹⁾
DC rated voltage range [U _R]	See CATALOG NUMBERS AND RATING OF STANDARD PRODUCTS
Rated capacitance (Normal capacitance range [C _R])	
Rated capacitance tolerance	
Failure rate level	1%/1000 h

Note⁽¹⁾: For operation 125°C, derate voltage linearly to 67% of 85°C voltage rating.

ORDERING INFORMATION

112		M		1602		475		M	
TYPE		SERIES		RATED VOLTAGE		CAPACITANCE		CAPACITANCE TOLERANCE	
Marking	Rated voltage	Marking	Capacitance	Marking	Capacitance	Marking	Capacitance	Marking	Capacitance Tolerance
6301	6.3VDC	155	1.5 μF	156	15 μF	157	150 μF	K	±10%
1002	10VDC	225	2.2 μF	226	22 μF	227	220 μF	M	±20%
1602	16VDC	335	3.3 μF	336	33 μF	337	330 μF		
2002	20VDC	475	4.7 μF	476	47 μF	477	470 μF		
2502	25VDC	685	6.8 μF	686	68 μF	687	680 μF		
3502	35VDC	106	10 μF	107	100 μF	108	1000 μF		
5002	50VDC								

DIMENSIONS

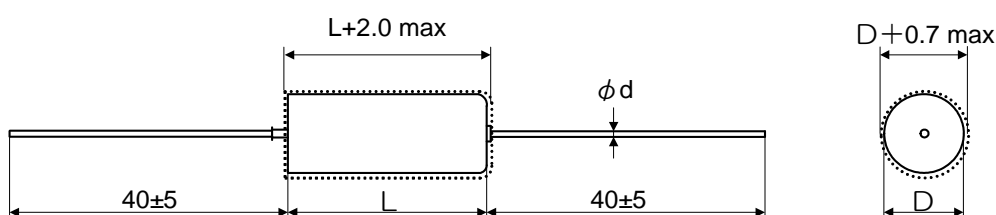

Unit : mm

Case size	D±0.5	L±1	φ d
A	3.15	6.3	0.5 ^{+0.1} / _{-0.025}
E	4.5	10.0	0.5 ^{+0.1} / _{-0.025}
B	4.5	11.5	0.5 ^{+0.1} / _{-0.025}
H	6.3	12.5	0.65 ^{+0.12} / _{-0.03}
C	7.1	16.0	0.65 ^{+0.12} / _{-0.03}
D	8.7	19.5	0.65 ^{+0.12} / _{-0.03}

MARKING

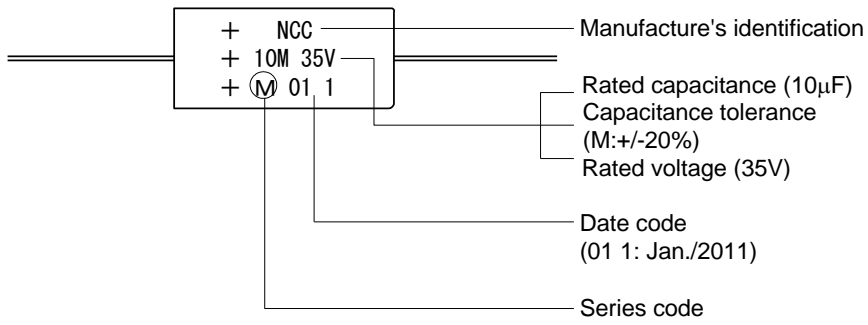

STANDARD RATING

R.V.(VDC) Cap.(μ F)	6.3	10	16	20	25	35	50
1.5						A	E
2.2					A	E	E
3.3				A		E	E
4.7			A			E	
6.8		A			E		B
10	A			E		B	H
15			E		B	H	
22		E		B		H	C
33	E		B		H	C	D
47	E	B		H		C	
68		B	H		C	D	
100	B	H		C	D	D	
150	H		C	D	D		
220	H	C	D	D			
330	C		D				
470	C	D					
680	D						
1000	D						

CATALOG NUMBERS AND RATING OF STANDARD PRODUCTS

March, 2011

Catalog Number (1)	U _R VDC	U _S VDC	C _R μF	Case code	Leakage current(DCL) μA			Dissipation factor			
					20°C	85°C	125°C	-55°C	20°C	85°C	125°C
112 M 6301 106	6.3	8	10	A	0.6	6	7.9	0.06	0.06	0.06	0.06
112 M 6301 336	↓	↓	33	E	2.1	21	26	0.06	0.06	0.06	0.06
112 M 6301 476	↓	↓	47	E	3.0	30	37	0.06	0.06	0.06	0.06
112 M 6301 107	↓	↓	100	B	6.3	63	79	0.08	0.08	0.08	0.08
112 M 6301 157	↓	↓	150	H	9.5	95	118	0.08	0.08	0.08	0.08
112 M 6301 227	↓	↓	220	H	14	140	173	0.08	0.08	0.08	0.08
112 M 6301 337	↓	↓	330	C	21	210	260	0.08	0.08	0.08	0.08
112 M 6301 477	↓	↓	470	C	30	300	370	0.10	0.10	0.10	0.12
112 M 6301 687	↓	↓	680	D	43	430	536	0.10	0.10	0.10	0.12
112 M 6301 108	↓	↓	1000	D	63	630	788	0.12	0.12	0.15	0.15
112 M 1002 685	10	13	6.8	A	0.7	7	8.5	0.06	0.06	0.06	0.06
112 M 1002 226	↓	↓	22	E	2.2	22	28	0.06	0.06	0.06	0.06
112 M 1002 476	↓	↓	47	B	4.7	47	59	0.06	0.06	0.06	0.06
112 M 1002 686	↓	↓	68	B	6.8	68	85	0.06	0.06	0.06	0.06
112 M 1002 107	↓	↓	100	H	10	100	125	0.08	0.08	0.08	0.08
112 M 1002 227	↓	↓	220	C	22	220	275	0.08	0.08	0.08	0.08
112 M 1002 477	↓	↓	470	D	47	470	588	0.10	0.10	0.10	0.12
112 M 1602 475	16	20	4.7	A	0.8	8	9.4	0.04	0.04	0.04	0.05
112 M 1602 156	↓	↓	15	E	2.4	24	30	0.06	0.06	0.06	0.06
112 M 1602 336	↓	↓	33	B	5.3	53	66	0.06	0.06	0.06	0.06
112 M 1602 686	↓	↓	68	H	11	110	136	0.06	0.06	0.06	0.06
112 M 1602 157	↓	↓	150	C	24	240	300	0.08	0.08	0.08	0.08
112 M 1602 227	↓	↓	220	D	35	350	440	0.08	0.08	0.08	0.08
112 M 1602 337	↓	↓	330	D	53	530	660	0.08	0.08	0.08	0.08
112 M 2002 335	20	25	3.3	A	0.7	7	8.3	0.04	0.04	0.04	0.05
112 M 2002 106	↓	↓	10	E	2.0	20	25	0.06	0.06	0.06	0.06
112 M 2002 226	↓	↓	22	B	4.4	44	55	0.06	0.06	0.06	0.06
112 M 2002 476	↓	↓	47	H	9.4	94	118	0.06	0.06	0.06	0.06
112 M 2002 107	↓	↓	100	C	20	200	250	0.08	0.08	0.08	0.08
112 M 2002 157	↓	↓	150	D	30	300	375	0.08	0.08	0.08	0.08
112 M 2002 227	↓	↓	220	D	44	440	550	0.08	0.08	0.08	0.08
112 M 2502 225	25	32	2.2	A	0.6	6	6.9	0.04	0.04	0.04	0.05
112 M 2502 685	↓	↓	6.8	E	1.7	17	21	0.06	0.06	0.06	0.06
112 M 2502 156	↓	↓	15	B	3.8	38	47	0.06	0.06	0.06	0.06
112 M 2502 336	↓	↓	33	H	8.3	83	103	0.06	0.06	0.06	0.06
112 M 2502 686	↓	↓	68	C	17	170	213	0.06	0.06	0.06	0.06
112 M 2502 107	↓	↓	100	D	25	250	313	0.08	0.08	0.08	0.08
112 M 2502 157	↓	↓	150	D	37	370	468	0.08	0.08	0.08	0.08
112 M 3502 155	35	44	1.5	A	0.5	5	6.6	0.04	0.04	0.04	0.05
112 M 3502 225	↓	↓	2.2	E	0.8	8	9.6	0.04	0.04	0.04	0.05
112 M 3502 335	↓	↓	3.3	E	1.2	12	14	0.04	0.04	0.04	0.05
112 M 3502 475	↓	↓	4.7	E	1.6	16	21	0.04	0.04	0.04	0.05
112 M 3502 106	↓	↓	10	B	3.5	35	44	0.06	0.06	0.06	0.06
112 M 3502 156	↓	↓	15	H	5.3	53	66	0.06	0.06	0.06	0.06
112 M 3502 226	↓	↓	22	H	7.7	77	96	0.06	0.06	0.06	0.06
112 M 3502 336	↓	↓	33	C	12	120	144	0.06	0.06	0.06	0.06
112 M 3502 476	↓	↓	47	C	16	160	206	0.06	0.06	0.06	0.06
112 M 3502 686	↓	↓	68	D	24	240	298	0.06	0.06	0.06	0.06
112 M 3502 107	↓	↓	100	D	35	350	437	0.08	0.08	0.08	0.08
112 M 5002 155	50	63	1.5	E	0.8	8	9.4	0.04	0.04	0.04	0.05
112 M 5002 225	↓	↓	2.2	E	1.1	11	14	0.04	0.04	0.04	0.05
112 M 5002 335	↓	↓	3.3	E	1.7	17	21	0.04	0.04	0.04	0.05
112 M 5002 685	↓	↓	6.8	B	3.4	34	43	0.06	0.06	0.06	0.06
112 M 5002 106	↓	↓	10	H	5.0	50	63	0.06	0.06	0.06	0.06
112 M 5002 226	↓	↓	22	C	11	110	138	0.06	0.06	0.06	0.06
112 M 5002 336	↓	↓	33	D	17	170	206	0.06	0.06	0.06	0.06

* U_R = Rated Voltage U_S = Surge Voltage C_R = Capacitance
 Note 1 : For Capacitance tolerance , insert "K" or "M" into _1

PERFORMANCE

No.	Item		Performance	Test method
1	Leakage Current (μ A)		Shall not exceed 0.01 CV or 0.5 whichever is greater.	JIS C 5101-1,4.9 Applied Voltage : Rated Voltage for 5 min. Temperature : 20°C
2	Capacitance (μ F)		Shall be within tolerance of the nominal value specified.	JIS C 5101-1,4.7 Frequency : 120 Hz \pm 20% Voltage : 0.5Vrms+1.5 ~2VDC Temperature : 20°C
3	Dissipation Factor		Shall not exceed the values shown in CATALOG NUMBERS AND RATING OF STANDARD PRODUCTS.	JIS C 5101-1,4.8 Frequency : 120 Hz \pm 20% Voltage : 0.5Vrms+1.5 ~2VDC Temperature : 20°C
4	Characteristics at High and LowTemperature			JIS C 5101-1,4.29
	Step1	Leakage Current Capacitance Dissipation Factor	Shall not exceed the value in No.1. Shall be within the specified tolerance. Shall not exceed the value in No.3.	Measuring temperature : 20 \pm 2°C
	Step2	Capacitance Change Dissipation Factor	Shall be within \pm 10% of the value at Step 1. Shall not exceed the values shown in CATALOG NUMBERS AND RATING OF STANDARD PRODUCTS.	Measuring temperature : -55 \pm 3°C
	Step3	Leakage Current Capacitance Change Dissipation Factor	Shall not exceed the value in No.1. Shall be within \pm 2% of the value at Step 1. Shall not exceed the value in No.3.	Measuring temperature : 20 \pm 2°C
	Step4	Leakage Current Capacitance Change Dissipation Factor	Shall not exceed 0.1 CV or 5 whichever is greater. Shall be within \pm 8% of the value at Step 1. Shall not exceed the values shown in CATALOG NUMBERS AND RATING OF STANDARD PRODUCTS.	Measuring temperature : 85 \pm 2°C
	Step5	Leakage Current Capacitance Change Dissipation Factor	Shall not exceed 0.125 CV or 6.3 whichever is greater. Shall be within \pm 12% of the value at Step 1. Shall not exceed the values shown in CATALOG NUMBERS AND RATING OF STANDARD PRODUCTS.	Measuring temperature : 125 \pm 2°C
	Step6	Leakage Current Capacitance Change Dissipation Factor	Shall not exceed the value in No.1. Shall be within \pm 2% of the value at Step 1. Shall not exceed the value in No.3.	Measuring temperature : 20 \pm 2°C
5	Surge	Leakage Current Capacitance Change Dissipation Factor Appearance	Shall not exceed the value in No.1. Shall be within \pm 5% of initial value. Shall not exceed the value in No.3. There shall be no evidence of mechanical damage.	JIS C 5101-1,4.26 Test temperature : 85 \pm 2°C, Applied Voltage :DC surge voltage Series protective resistance : 1000 Ω Discharge resistance : 1000 Ω
6	Sleeving	Dielectric withstanding voltage	There shall be no dielectric breakdown.	JIS C 5101-1,4.6(c) Voltage: 2000VDC Duration : 1 min.
		Insulation resistanc	More than 1000M Ω	JIS C 5101-1,4.5(c) Voltage: 100VDC Duration : 2 min.
7	Terminal strength	Tensile strength	No fault such as breakage and loosening terminal	JIS C 5101-1,4.13.1 Applied force: 5N (d= 0.5) ,10N (d= 0.65) Duration:10 \pm 1 s
		Bending strength		JIS C 5101-1,4.13.2 Bending force : 2.5N (d= 0.5), 5N (d= 0.65) Bending cycle:2

No.	Item		Performance	Test method
8	Vibration	Capacitance	Initial value to remain steady during measurement.	JIS C 5101-1,4.17 Frequency range : 10 ~ 2000 Hz Swing width : 1.5 mm Peak acceleration : 196m/s ² Vibration direction : 2 directions with mutually right-angled Duration : 4 hours in each of these mutually perpendicular directions (total 8 hours)
		Appearance	There shall be no evidence of mechanical damage.	
9	Shock		There shall be no intermittent contact of 0.5 ms or greater, short, or open. Nor shall there be any spark discharge, insulation breakdown, or evidence of mechanical damage.	JIS C 5101-1,4.19 Peak acceleration :981 m/s ² (100G) Duration : 6 ms Wave form : Sawtooth
10	Solderability		Shall be covered to over 3/4 of terminal surface by new soldering.	JIS C 5101-1,4.15 Solder temperature : 230 ± 5°C Dipping time : 2 ± 0.5 s Dipping depth : 2.0 to 2.5 mm from the terminal base
11	Resistance to Soldering Heat	Leakage	Shall not exceed the value in No.1.	JIS C 5101-1,4.14 Solder temperature: 260 ± 5°C Dipping time: 10 ± 1 s Dipping depth : 2.0 to 2.5 mm from the terminal base
		Current	Shall be within ± 3% of initial value.	
		Capacitance Change	Shall not exceed the value in No.3.	
		Dissipation Factor	There shall be no evidence of mechanical damage.	
Appearance	There shall be no evidence of mechanical damage.			
12	Component solvent resistance	Appearance	There shall be no evidence of mechanical damage.	JIS C 5101-1, 4.31 Temperature : 23 ± 5°C Dipping time : 5 ± 0.5 min. Solvent : 2-propanol (Isopropyl alcohol)
13	Solvent resistance of marking	Visual examination	After the test the marking shall be legible.	JIS C 5101-1, 4.32 Temperature : 23 ± 5°C Dipping time : 5 ± 0.5 min. Solvent : 2-propanol (Isopropyl alcohol)
14	Seal		There shall be no evidence of leakage.	JIS C 5101-1,4.20 Test condition : Qc, method 1 Temperature : 125 ⁺⁵ / ₋₁ °C Duration : 1min.
15	Rapid Change of Temperature and immersion cycle	Rapid Change of Temperature	Measurements after cycling, are not applicable.	JIS C 5101-1,4.16 Step 1 : -55 ⁰ / ₋₃ °C, 30 ± 3 min. Step 2 : 25 ⁺¹⁰ / ₋₅ °C, 3 min. max. Step 3 : 125 ⁺³ / ₀ °C, 30 ± 3 min. Step 4 : 25 ⁺¹⁰ / ₋₅ °C, 3 min. max. Number of cycles : 5
		Immersion cycle	Shall not exceed the value in No.1.	
16	Moisture resistance	Leakage	Shall not exceed the value in No.1.	JIS C 60068-2-38 High temperature : 65 ⁺⁵ / ₀ °C 90 to 98%R.H. Low temperature : 25 ⁰ / ₋₂ °C 90 to 98%R.H.
		Current	Shall be within ± 5% of initial value.	
		Capacitance Change	Shall not exceed the value in No.3.	
		Dissipation Factor	There shall be no evidence of mechanical damage.	
Appearance	There shall be no evidence of mechanical damage.			
17	Salt spray		There shall be no harmful corrosion, and at least 90% of any exposed surfaca of the capacitor shall be protected by the finish. There shall be no unwrapping of, or mechanical damage to, the sleeving. Marking shall remain legible.	JIS C 60068-2-11 Temperature : 35 ± 2°C Salt solution : 5 ± 1% (wt) Duration : 48 ± 4 h
18	Endurance	Leakage	Shall not exceed the value in No.1.	JIS C 5101-1,4.23 Test temperature and applied voltage : 85 ± 2°C and rated voltage or 125 ± 3°C and 2/3 × rated voltage Duration : 2000 ⁺⁷² h Power supply impedance : 3 Ω or less
Current	Shall be within ± 5% of initial value.			
Capacitance Change	Shall not exceed the value in No.3.			
Dissipation Factor	There shall be no evidence of mechanical damage.			
Appearance	There shall be no evidence of mechanical damage.			

FREQUENCY CHARACTERISTICS

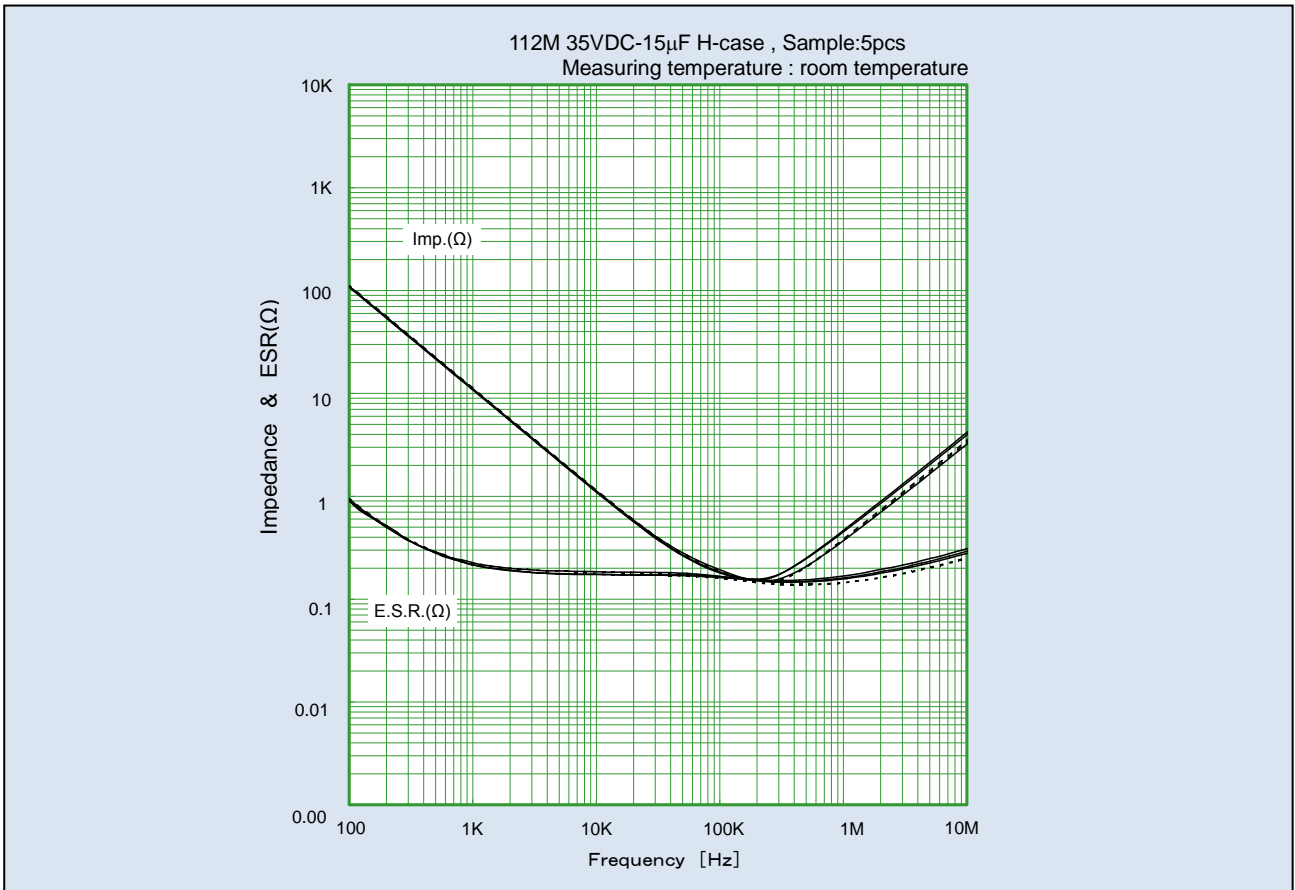

TEMPERATURE CHARACTERISTICS

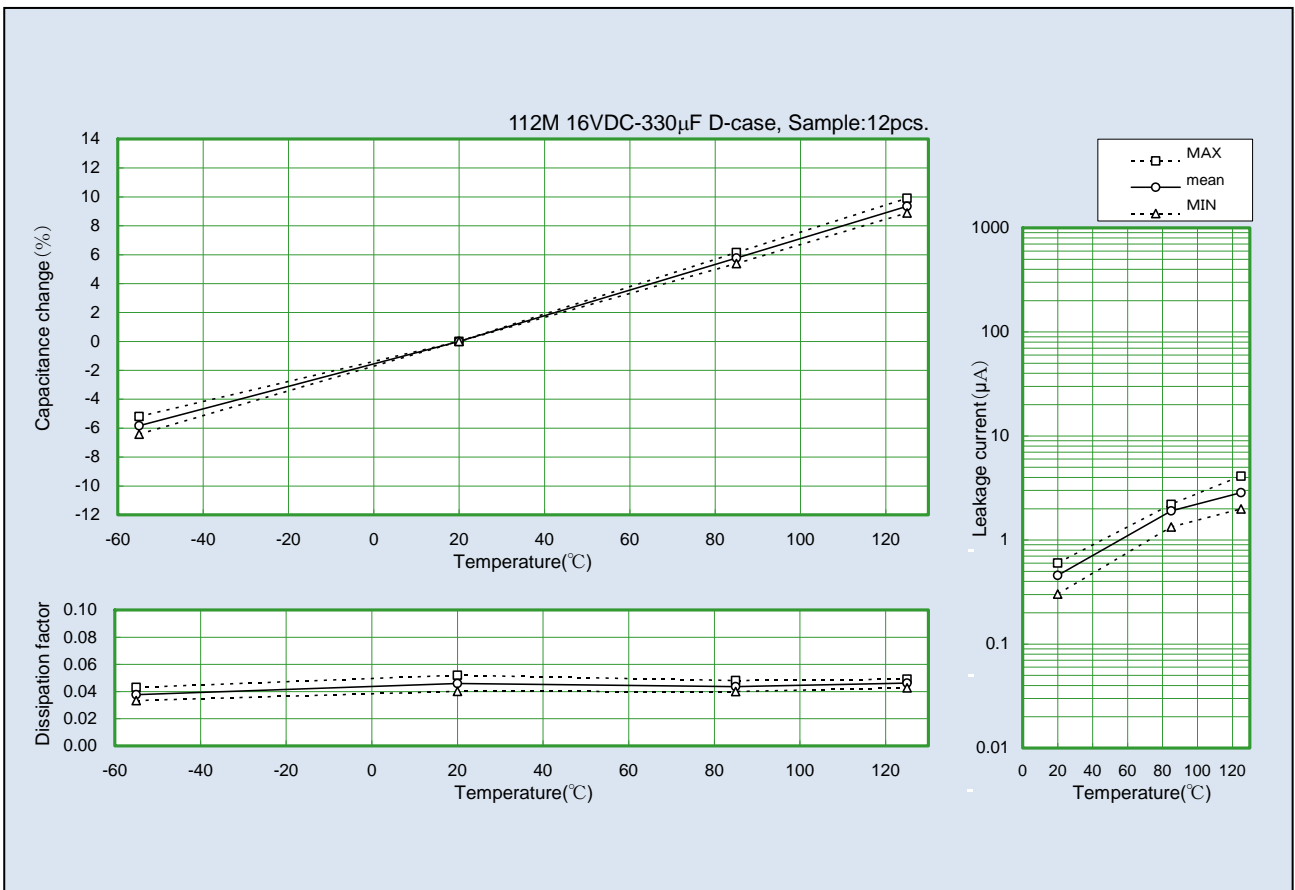

ENDURANCE 85°C, RATED VOLTAGE

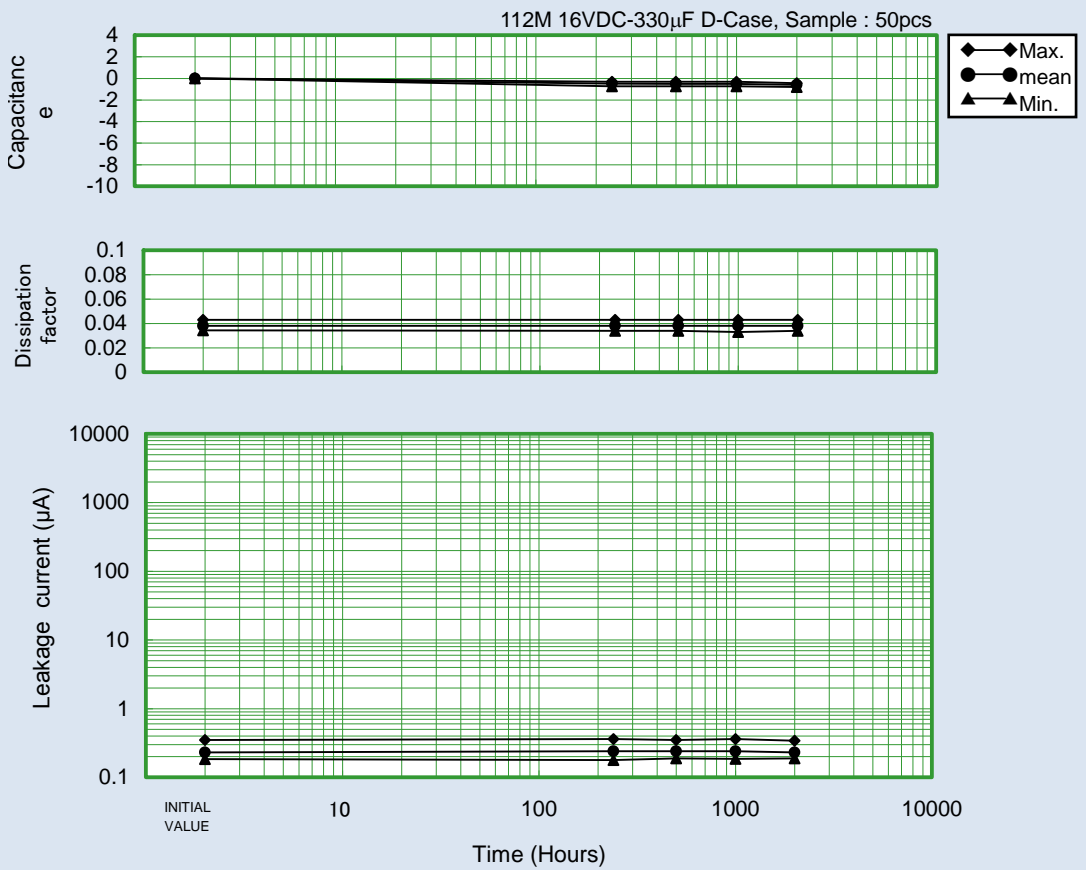
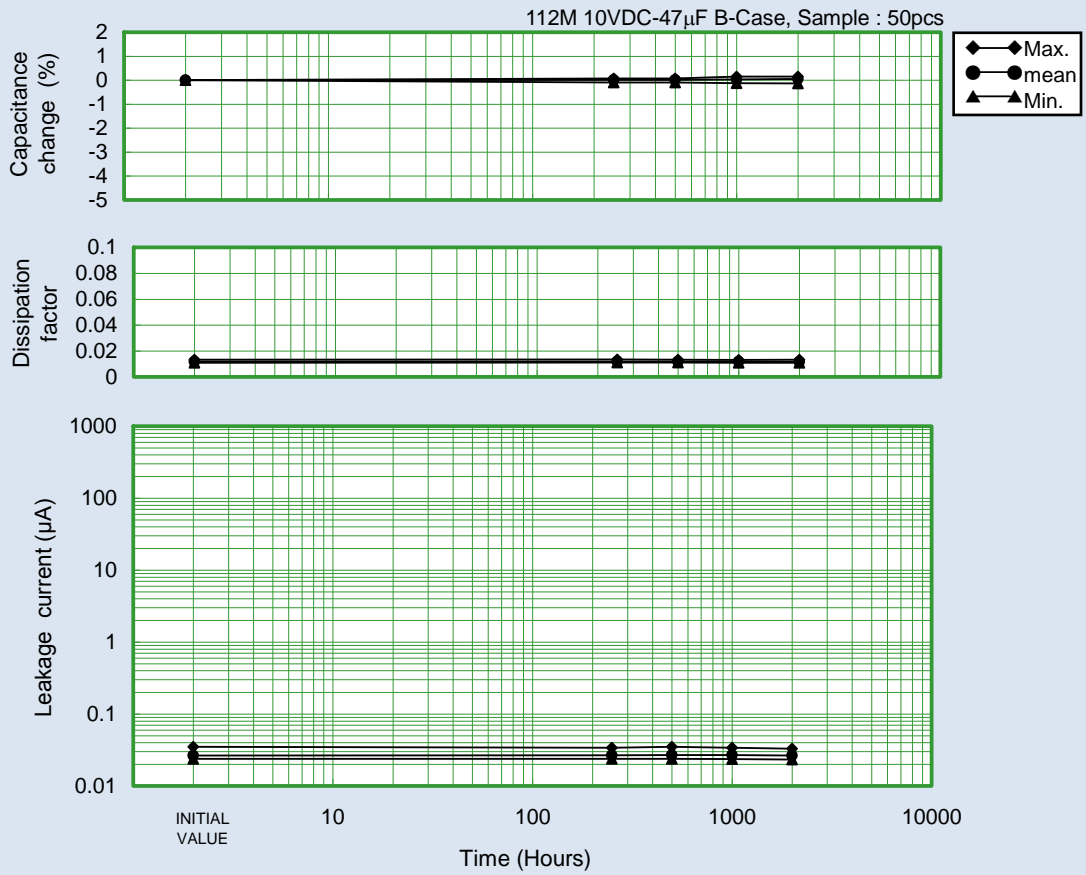

⚠ Application Notes for Tantalum Solid Electrolytic Capacitor (Hermetically sealed capacitors in metal case)

1. Operating Voltage

Tantalum Solid Electrolytic Capacitor shall be operated at the rated voltage or lower.

Rated voltage: The "rated voltage" refers to the maximum DC voltage that is allowed to be continuously applied between the capacitor terminals at the rated temperature.

Surge voltage: The "surge voltage" refers to the voltage that is allowed to be instantaneously applied to the capacitor at the rated temperature or the maximum working temperature. The capacitor shall withstand the voltage when a 30-second cycle of application of the voltage through a 1000 Ω series resistance is repeated 1000 times in 6-minute periods.

Rated voltage (VDC)	6.3	10	16	20	25	35	50
Surge voltage (VDC)	8	13	20	25	32	44	63

When designing the circuit, the equipment's required reliability must be considered and appropriate voltage derating must be performed. Figure 1 shows the recommended voltage derating curve for Tantalum capacitors as described by NASA APPLICATION NOTES.

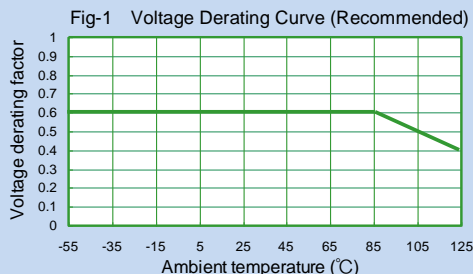

2. Application that contain AC Voltage

Special attention to the following 3 items.

- (1) The sum of the DC bias voltage and the positive peak value of the AC voltage should not exceed the rated voltage.
- (2) Reverse voltage should not exceed the allowable values of the negative peak AC voltage.
- (3) Ripple current should not exceed the allowable values.

3. Reverse Voltage

Tantalum solid electrolytic capacitor is polarity. Please do not impress reverse voltage. As well, please confirm the potential of the tester beforehand when both ends of the capacitor are checked with the tester etc.

4. Permissible Ripple Voltage

Permissible ripple voltage is determined by the heat loss of the element and heat radiation of the lead wire. This is influenced by capacitance, ESR, operating temperature, and frequency or ripple. Please consult Matsuo's Engineering Bulletin for details on calculating ripple current values.

5. Application on low-impedance circuit

The failure rate of low impedance circuit at 0.1Ω/V is about five times greater than that of a 1Ω/V circuit. To curtail this higher failure rate, tantalum capacitors used in low impedance circuits, such as filters for power supplies, particularly switching power supplies, or for noise by-passing, require that operating voltage be derated to less than half of the rated voltage. Actually, less than 1/3 of the rated voltage is recommended.

6. Non Polar Application(BACK TO BACK)

Tantalum capacitors can be used as a non-polar unit if two capacitors are connected "BACK-TO-BACK" when reserve voltage is applied at a more than permissible value, or in a purely AC circuit. The two capacitors should both be of the same rated voltage and capacitance tolerance, and they should both be twice the required capacitance value.

Ripple Voltage: Permissible Ripple Voltage shall not exceed the value allowed for either C1 or C2 (This will be the same, as the capacitors should be identical.)

Capacitance: $(C1 \times C2) / (C1 + C2)$

Leakage Current: If terminal A is (+), the Leakage Current will be equal to C1's Leakage Current.
If terminal B is (+), the Leakage Current will be equal to C2's Leakage Current.

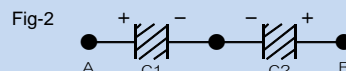

7. Soldering

The soldering of Type 112 should be operated per the following recommended conditions.

- (1) Flow Soldering (Direct heating from the substrate)

Solder temperature: 260°C or less

Dipping time: 10 s

Note1: Noted that solder part of hermetic could be melted If soldering temperature is too high or dipping time is too long for the operation.

- (2) Soldering with a Soldering Iron

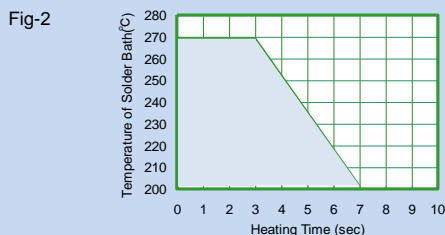

Note2: Please be noted that soldering should be done more than 4mm apart from product body.

8. Example of trouble phenomenon happening by excessive heating when soldering

When mounting, the following breakdown phenomena might be caused when excessive heating that exceeds the above-mentioned tolerance is done. Therefore, please pay attention to the operation.

In a case that solder is used for cathode connection of molding type product, Ag in silver paste could merge into solder if solder in product have melted. That might cause excessive Leakage Current and Short etc. by changing in deterioration in DF and the high frequency impedance or internal stresses in that case.

Mechanical stress according to heat stress and expansion shrinkage or concentrations of internal stress might increase failure rate. Defect sealing could sometimes come for solder melting in seal entrance part of Type 112. Or, solder flows, might become a bridge between inside and outside circles of the Hermetic seal, be good at the solder grain if inhaled, and the phenomenon such as a short or intermittent shorts be caused.

9. Flux

Please use flux as much as possible with non-acidity and little content of both chlorine and amine.

10. Cleaning

Cleaning by organic solvent may damage capacitor's appearance and performance. However, our capacitors are not effected even when soaked at 20 ~ 30°C 2-propanol for 5 minutes. When introducing new cleaning methods or changing the cleaning term, please consult us.

11. Protective Resin Coating

After components are assembled to substrate, a protective resin coating is sometimes applied. As this resin coating cures, it gives mechanical and thermal stress to Tantalum capacitors. This stress can cause damage to the capacitors, which affects their reliability. Before using a resin coating, proper research must be done in regards to the material and process to insure that excessive stress will not be applied to capacitors and other components.

12. Vibration

Approximately 300 G shall be applied to a capacitor, when dropped from 1 meter to a concrete floor. Although capacitors are made to withstand this drop test, stress from shock due to falling or striking does cause damage to the capacitors and increases failure rates. Do not subject capacitors to this type of mechanical stress.

13. Additional Notes

- When more than one capacitor is connected in series, a resistor that can distribute the voltage equally to the capacitors shall be connected in parallel.
- The capacitor cases shall not be cut even if the mounting space is insufficient.
- Do not process lead wire terminal in a way other than cutting or bending the part that projects from printed circuit board (plated through hole).
- Do not add the outside power more than regulations to lead wire terminal. Do not add excessive power to capacitor.
- During a customers aging process, voltage should remain under the rated voltage at all times.
- Capacitors should never be touched or manipulated while operating.
- Capacitors are not meant to be dismantled.
- When testing capacitors, please examine the power source before conducting test to insure the tester's polarity and applied voltage.
- Do not touch terminals of other parts if electrode is applied and checked while energizing. Do not bend the lead wire terminal with the electrode testers.
- In the event of a capacitor burning, smoking, or emitting an offensive smell during operation, please turn the circuit "off" and keep hands and face away from the burning capacitor.
- If a capacitor be electrical shorted, it becomes hot, and the capacitor element may ignite. In this case, the printed board may be burnt out.
- A for capacitors (Type 112) with the metal casing, pressure in the cases might go up by Short before they explode, and then high-temperature solder might disperse.
- Capacitors should be stored at room temperature under low humidity. Capacitors should never be stored under direct sunlight, and should be stored in an environment containing dust.
- If the capacitors will be operated in a humid environment, they should be sealed with a compound under proper conditions.
- Capacitors should not be stored or operated in environments containing acids, alkalis or active gasses.
- When capacitors are disposed of as "scrap" or waste, they should be treated as Industria Waste since they contain various metals and polymers.
- Capacitors submitted as samples should not be used for production purposes.

These application notes are prepared based on "Guideline of notabilia for fixed tantalum electrolytic capacitors with solid electrolyte for use in electronic equipment" (EIAJ RCR-2368) issued by Japan Electronics and Information Technology Industries Association (JEITA). For the details of the instructions (explanation, reasons and concrete examples), please refer to this guideline, or consult our Sales Department.



MATSUO ELECTRIC CO., LTD.

Please feel free to ask our Sales Department for more information on Tantalum Solid Electrolytic Capacitor .

Overseas Sales Dep. 5-3,3-Chome,Sennari-cho,Toyonaka-shi,Osaka 561-8558,Japan Tel : 06-6332-0883 Fax : 06-6332-0920
Head office 5-3,3-Chome,Sennari-cho,Toyonaka-shi,Osaka 561-8558,Japan Tel : 06-6332-0871 Fax : 06-6331-1386
URL <http://www.ncc-matsuo.co.jp/>

Specifications on this catalog are subject to change without prior notice. Please inquire of our Sales Department to confirm specifications prior to use.