

## MM74HC221A Dual Non-Retriggerable Monostable Multivibrator

### General Description

The MM74HC221A high speed monostable multivibrators (one shots) utilize advanced silicon-gate CMOS technology. They feature speeds comparable to low power Schottky TTL circuitry while retaining the low power and high noise immunity characteristic of CMOS circuits.

Each multivibrator features both a negative, A, and a positive, B, transition triggered input, either of which can be used as an inhibit input. Also included is a clear input that when taken low resets the one shot. The MM74HC221A can be triggered on the positive transition of the clear while A is held LOW and B is held HIGH.

The MM74HC221A is a non-retriggerable, and therefore cannot be retriggered until the output pulse times out.

Pulse width stability over a wide range of temperature and supply is achieved using linear CMOS techniques. The output pulse equation is simply:  $PW = (R_{EXT}) (C_{EXT})$ ; where PW

is in seconds, R is in ohms, and C is in farads. All inputs are protected from damage due to static discharge by diodes to  $V_{CC}$  and ground.

### Features

- Typical propagation delay: 40 ns
- Wide power supply range: 2V–6V
- Low quiescent current: 80  $\mu$ A maximum (74HC Series)
- Low input current: 1  $\mu$ A maximum
- Fanout of 10 LS-TTL loads
- Simple pulse width formula  $T = RC$
- Wide pulse range: 400 ns to  $\infty$  (typ)
- Part to part variation:  $\pm 5\%$  (typ)
- Schmitt Trigger A & B inputs enable infinite signal input rise or fall times

### Ordering Code:

Order Number	Package Number	Package Description
MM74HC221AM	M16A	16-Lead Small Outline Integrated Circuit (SOIC), JEDEC MS-012, 0.150" Narrow
MM74HC221ASJ	M16D	16-Lead Small Outline Package (SOP), EIAJ TYPE II, 5.3mm Wide
MM74HC221AMTC	MTC16	16-Lead Thin Shrink Small Outline Package (TSSOP), JEDEC MO-153, 4.4mm Wide
MM74HC221AN	N16E	16-Lead Plastic Dual-In-Line Package (PDIP), MS-001, 0.300" Wide

Devices also available in Tape and Reel. Specify by appending the suffix letter "X" to the ordering code.

### Connection Diagrams

Pin Assignments for DIP, SOIC, SOP and TSSOP



Top View

**Note:** Pin 6 and Pin 14 must be hard-wired to GND.

Timing Component

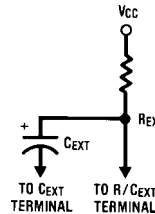

Truth Table

Inputs			Outputs	
Clear	A	B	Q	$\bar{Q}$
L	X	X	L	H
X	H	X	L	H
X	X	L	L	H
H	L	↑	⌊	⌋
H	↓	H	⌋	⌊
↑	L	H	⌋	⌊

H = HIGH Level  
 L = LOW Level  
 ↑ = Transition from LOW-to-HIGH  
 ↓ = Transition from HIGH-to-LOW  
 ⌋ = One HIGH Level Pulse  
 ⌊ = One LOW Level Pulse  
 X = Irrelevant

Logic Diagram

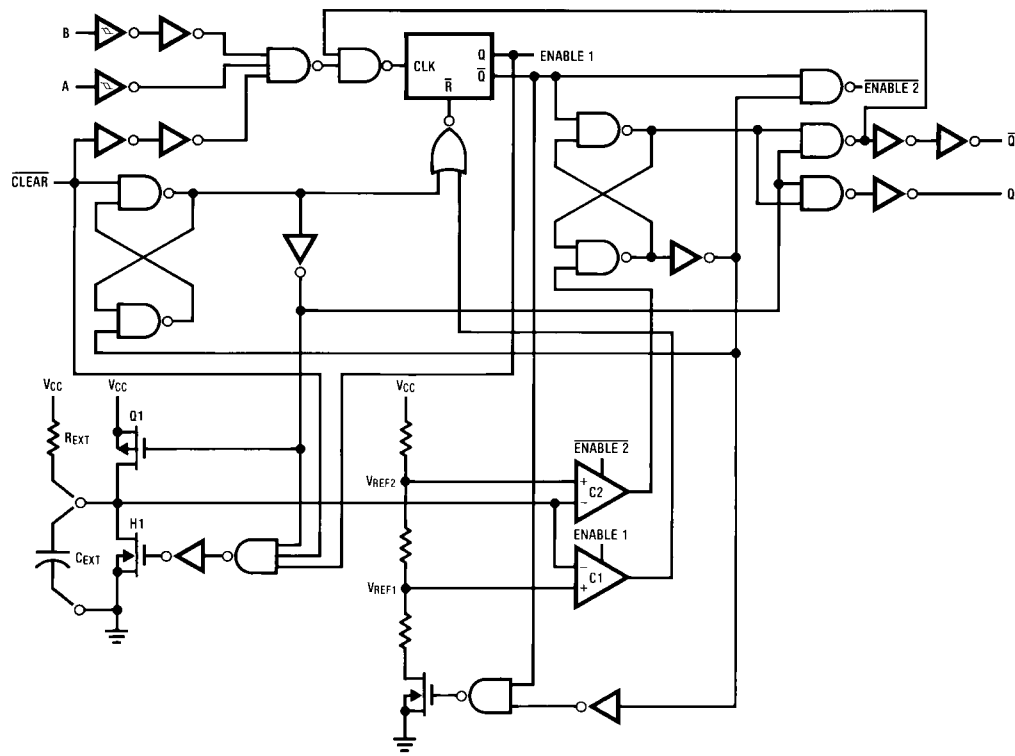

**Absolute Maximum Ratings** (Note 1)

(Note 2)

Supply Voltage ( $V_{CC}$ )	-0.5V to +7.0V
DC Input Voltage ( $V_{IN}$ )	-1.5V to $V_{CC}+1.5V$
DC Output Voltage ( $V_{OUT}$ )	-0.5V to $V_{CC}+0.5V$
Clamp Diode Current ( $I_{IK}, I_{OK}$ )	$\pm 20$ mA
DC Output Current, per pin ( $I_{OUT}$ )	$\pm 25$ mA
DC $V_{CC}$ or GND Current, per pin ( $I_{CC}$ )	$\pm 50$ mA
Storage Temperature Range ( $T_{STG}$ )	-65°C to +150°C
Power Dissipation ( $P_D$ )	
(Note 3)	600 mW
S.O. Package only	500 mW
Lead Temperature ( $T_L$ )	
(Soldering 10 seconds)	260°C

**Recommended Operating Conditions**

	Min	Max	Units
Supply Voltage ( $V_{CC}$ )	2	6	V
DC Input or Output Voltage ( $V_{IN}, V_{OUT}$ )	0	$V_{CC}$	V
Operating Temperature Range ( $T_A$ )	-40	+85	°C
Maximum Input Rise and Fall Time (Clear Input)			
	$V_{CC} = 2.0V$	1000	ns
	$V_{CC} = 4.5V$	500	ns
	$V_{CC} = 6.0V$	400	ns

**Note 1:** Maximum Ratings are those values beyond which damage to the device may occur.

**Note 2:** Unless otherwise specified all voltages are referenced to ground.

**Note 3:** Power Dissipation temperature derating — plastic "N" package: — 12 mW/°C from 65°C to 85°C.

**DC Electrical Characteristics** (Note 4)

Symbol	Parameter	Conditions	$V_{CC}$	$T_A = 25^\circ\text{C}$		$T_A = -40 \text{ to } 85^\circ\text{C}$		$T_A = -55 \text{ to } 125^\circ\text{C}$		Units
				Typ	Guaranteed Limits					
$V_{IH}$	Minimum HIGH Level Input Voltage		2.0V		1.5	1.5	1.5	V		
			4.5V		3.15	3.15	3.15	V		
			6.0V		4.2	4.2	4.2	V		
$V_{IL}$	Maximum LOW Level Input Voltage		2.0V		0.3	0.3	0.3	V		
			4.5V		0.9	0.9	0.9	V		
			6.0V		1.2	1.2	1.2	V		
$V_{OH}$	Minimum HIGH Level Output Voltage	$V_{IN} = V_{IH}$ or $V_{IL}$ $ I_{OUT}  \leq 20 \mu\text{A}$	2.0V	2.0	1.9	1.9	1.9	V		
			4.5V	4.5	4.4	4.4	4.4	V		
			6.0V	6.0	5.9	5.9	5.9	V		
		$V_{IN} = V_{IH}$ or $V_{IL}$ $ I_{OUT}  \leq 4.0 \text{ mA}$ $ I_{OUT}  \leq 5.2 \text{ mA}$	4.5V	4.2	3.98	3.84	3.7	V		
			6.0V	5.7	5.48	5.34	5.2	V		
$V_{OL}$	Maximum LOW Level Output Voltage	$V_{IN} = V_{IH}$ or $V_{IL}$ $ I_{OUT}  \leq 20 \mu\text{A}$	2.0V	0	0.1	0.1	0.1	V		
			4.5V	0	0.1	0.1	0.1	V		
			6.0V	0	0.1	0.1	0.1	V		
		$V_{IN} = V_{IH}$ or $V_{IL}$ $ I_{OUT}  \leq 4.0 \text{ mA}$ $ I_{OUT}  \leq 5.2 \text{ mA}$	4.5V	0.2	0.26	0.33	0.4	V		
			6.0V	0.2	0.26	0.33	0.4	V		
$I_{IN}$	Maximum Input Current (Pins 7, 15)	$V_{IN} = V_{CC}$ or GND	6.0V		$\pm 0.5$	$\pm 5.0$	$\pm 5.0$	$\mu\text{A}$		
$I_{IN}$	Maximum Input Current (all other pins)	$V_{IN} = V_{CC}$ or GND	6.0V		$\pm 0.1$	$\pm 1.0$	$\pm 1.0$	$\mu\text{A}$		
$I_{CC}$	Maximum Quiescent Supply Current (standby)	$V_{IN} = V_{CC}$ or GND $I_{OUT} = 0 \mu\text{A}$	6.0V		8.0	80	160	$\mu\text{A}$		
$I_{CC}$	Maximum Active Supply Current (per monostable)	$V_{IN} = V_{CC}$ or GND $R/C_{EXT} = 0.5V_{CC}$	2.0V	36	80	110	130	$\mu\text{A}$		
			4.5V	0.33	1.0	1.3	1.6	mA		
			6.0V	0.7	2.0	2.6	3.2	mA		

**Note 4:** For a power supply of  $5V \pm 10\%$  the worst-case output voltages ( $V_{OH}$ , and  $V_{OL}$ ) occur for HC at 4.5V. Thus the 4.5V values should be used when designing with this supply. Worst-case  $V_{IH}$  and  $V_{IL}$  occur at  $V_{CC} = 5.5V$  and 4.5V respectively. (The  $V_{IH}$  value at 5.5V is 3.85V.) The worst-case leakage current ( $I_{IN}$ ,  $I_{CC}$ , and  $I_{OZ}$ ) occur for CMOS at the higher voltage and so the 6.0V values should be used.

## AC Electrical Characteristics

$V_{CC} = 5V$ ,  $T_A = 25^\circ C$ ,  $C_L = 15$  pF,  $t_r = t_f = 6$  ns

Symbol	Parameter	Conditions	Typ	Guaranteed Limit	Units
$t_{PLH}$	Maximum Trigger Propagation Delay A, B or Clear to Q		22	36	ns
$t_{PHL}$	Maximum Trigger Propagation Delay A, B or Clear to $\bar{Q}$		25	42	ns
$t_{PHL}$	Maximum Propagation Delay Clear to Q		20	31	ns
$t_{PLH}$	Maximum Propagation Delay Clear to $\bar{Q}$		22	33	ns
$t_W$	Minimum Pulse Width A, B or Clear		14	26	ns
$t_{REM}$	Minimum Clear Removal Time			0	ns
$t_{WQ(MIN)}$	Minimum Output Pulse Width	$C_{EXT} = 28$ pF $R_{EXT} = 2$ k $\Omega$	400		ns
$t_{WQ}$	Output Pulse Width	$C_{EXT} = 1000$ pF $R_{EXT} = 10$ k $\Omega$	10		$\mu s$

## AC Electrical Characteristics

$C_L = 50$  pF,  $t_r = t_f = 6$  ns (unless otherwise specified)

Symbol	Parameter	Conditions	$V_{CC}$	$T_A = 25^\circ C$		$T_A = -40$ to $85^\circ C$	$T_A = -55$ to $125^\circ C$	Units	
				Typ	Guaranteed Limits				
$t_{PLH}$	Maximum Trigger Propagation Delay A, B or Clear to Q		2.0V	77	169	194	210	ns	
			4.5V	26	42	51	57	ns	
			6.0V	21	32	39	44	ns	
$t_{PHL}$	Maximum Trigger Propagation Delay A, B or Clear to $\bar{Q}$		2.0V	88	197	229	250	ns	
			4.5V	29	48	60	67	ns	
			6.0V	24	38	46	51	ns	
$t_{PHL}$	Maximum Propagation Delay Clear to Q		2.0V	54	114	132	143	ns	
			4.5V	23	34	41	45	ns	
			6.0V	19	28	33	36	ns	
$t_{PLH}$	Maximum Propagation Delay Clear to $\bar{Q}$		2.0V	56	116	135	147	ns	
			4.5V	25	36	42	46	ns	
			6.0V	20	29	34	37	ns	
$t_W$	Minimum Pulse Width A, B, Clear		2.0V	57	123	144	157	ns	
			4.5V	17	30	37	42	ns	
			6.0V	12	21	27	30	ns	
$t_{REM}$	Minimum Clear Removal Time		2.0V		0	0	0	ns	
			4.5V		0	0	0	ns	
			6.0V		0	0	0	ns	
$t_{TLH}, t_{THL}$	Maximum Output Rise and Fall Time		2.0V	30	75	95	110	ns	
			4.5V	8	15	19	22	ns	
			6.0V	7	13	16	19	ns	
$t_{WQ(MIN)}$	Minimum Output Pulse Width	$C_{EXT} = 28$ pF $R_{EXT} = 2$ k $\Omega$ $R_{EXT} = 6$ k $\Omega$ ( $V_{CC} = 2V$ )	2.0V	1.5				$\mu s$	
			4.5V	450				ns	
			6.0V	380				ns	
$t_{WQ}$	Output Pulse Width	$C_{EXT} = 0.1$ $\mu F$ $R_{EXT} = 10$ k $\Omega$	Min	5.0V	1	0.9	0.86	0.85	ms
			Max	5.0V	1	1.1	1.14	1.15	ms
$C_{PD}$	Power Dissipation Capacitance (Note 5)			87				pF	
$C_{IN}$	Maximum Input Capacitance (Pins 7 & 15)			12	20	20	20	pF	
$C_{IN}$	Maximum Input Capacitance (other inputs)			6	10	10	10	pF	

**Note 5:**  $C_{PD}$  determines the no load dynamic power consumption,  $P_D = C_{PD} V_{CC}^2 f + I_{CC} V_{CC}$ , and the no load dynamic current consumption,  $I_S = C_{PD} V_{CC} f + I_{CC}$ .

## Theory of Operation

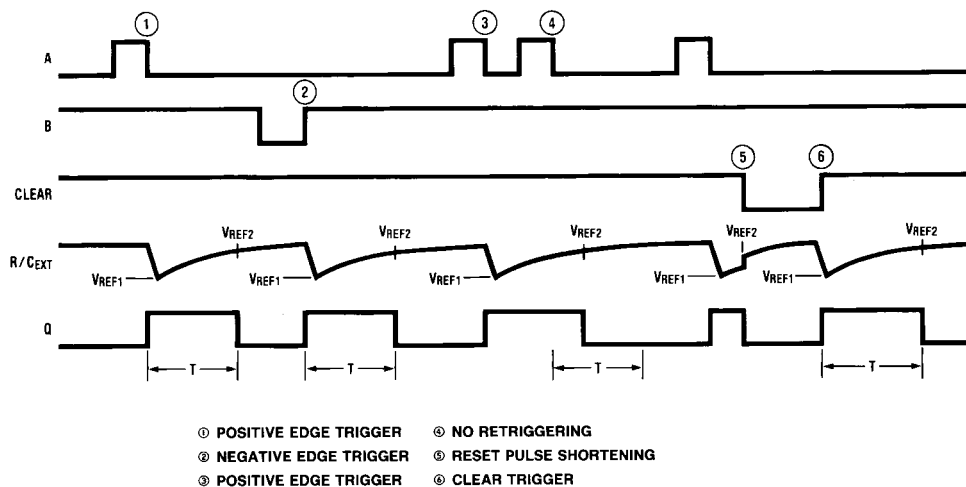

FIGURE 1.

### TRIGGER OPERATION

As shown in *Figure 1* and the logic diagram before an input trigger occurs, the monostable is in the quiescent state with the Q output LOW, and the timing capacitor  $C_{EXT}$  completely charged to  $V_{CC}$ . When the trigger input A goes from  $V_{CC}$  to GND (while inputs B and clear are held to  $V_{CC}$ ) a valid trigger is recognized, which turns on comparator C1 and N-channel transistor N11. At the same time the output latch is set. With transistor N1 on, the capacitor  $C_{EXT}$  rapidly discharges toward GND until  $V_{REF1}$  is reached. At this point the output of comparator C1 changes state and transistor N1 turns off. Comparator C1 then turns off while at the same time comparator C2 turns on. With transistor N1 off, the capacitor  $C_{EXT}$  begins to charge through the timing resistor,  $R_{EXT}$ , toward  $V_{CC}$ . When the voltage across  $C_{EXT}$  equals  $V_{REF2}$ , comparator C2 changes state causing the output latch to reset (Q goes LOW) while at the same time disabling comparator C2. This ends the timing cycle with the monostable in the quiescent state, waiting for the next trigger.

A valid trigger is also recognized when trigger input B goes from GND to  $V_{CC}$  (while input A is at GND and input clear is at  $V_{CC}$ ). The MM74HC221 can also be triggered when clear goes from GND to  $V_{CC}$  (while A is at Gnd and B is at  $V_{CC}$ ).

It should be noted that in the quiescent state  $C_{EXT}$  is fully charged to  $V_{CC}$  causing the current through resistor  $R_{EXT}$  to be zero. Both comparators are "off" with the total device current due only to reverse junction leakages. An added feature of the MM74HC221 is that the output latch is set via the input trigger without regard to the capacitor voltage. Thus, propagation delay from trigger to Q is independent of the value of  $C_{EXT}$ ,  $R_{EXT}$ , or the duty cycle of the input waveform.

The MM74HC221 is non-retriggerable and will ignore input transitions on A and B until it has timed out 3 and 4.

### RESET OPERATION

These one shots may be reset during the generation of the output pulse. In the reset mode of operation, an input pulse on clear sets the reset latch and causes the capacitor to be fast charged to  $V_{CC}$  by turning on transistor Q1 5. When the voltage on the capacitor reaches  $V_{REF2}$ , the reset latch will clear and then be ready to accept another pulse. If the clear input is held LOW, any trigger inputs that occur will be inhibited and the Q and  $\bar{Q}$  outputs of the output latch will not change. Since the Q output is reset when an input low level is detected on the Clear input, the output pulse T can be made significantly shorter than the minimum pulse width specification.

Typical Output Pulse Width vs. Timing Components

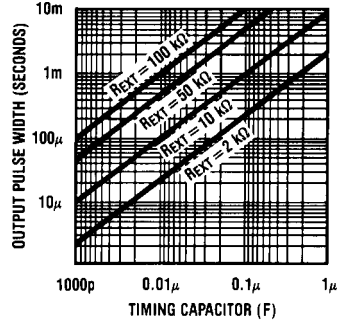

Typical 1ms Pulse Width Variation vs. Supply

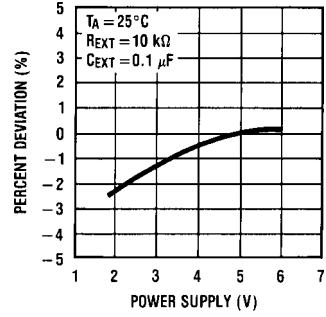

Typical Distribution of Output Pulse Width, Part to Part

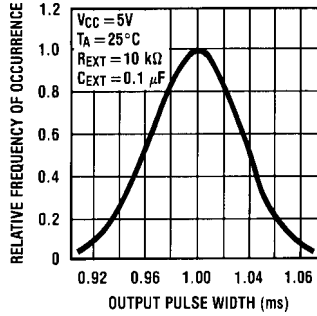

Minimum REXT vs. Supply Voltage

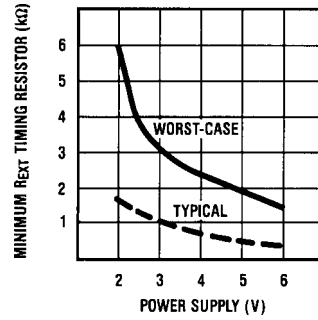

Typical 1 ms Pulse Width Variation vs. Temperature

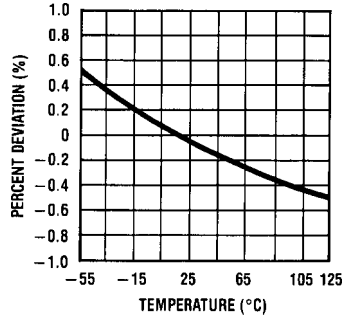

Note: R and C are not subjected to temperature. The C is polypropylene.

**Physical Dimensions** inches (millimeters) unless otherwise noted

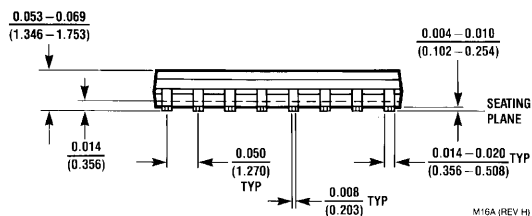
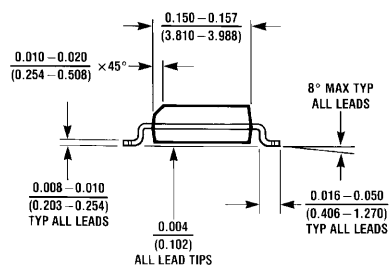
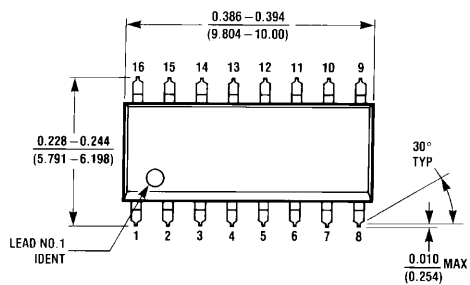

**16-Lead Small Outline Integrated Circuit (SOIC), JEDEC MS-012, 0.150" Narrow Package Number M16A**

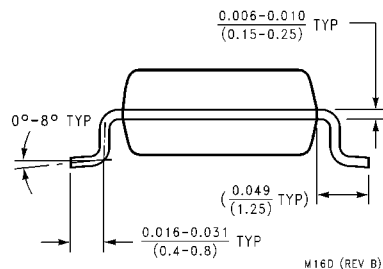
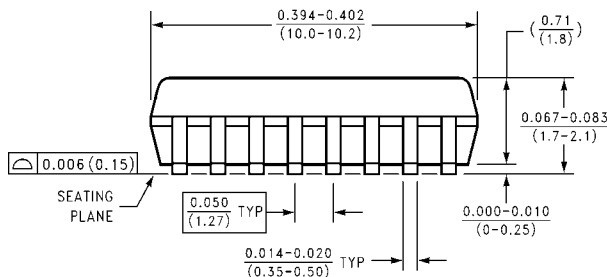
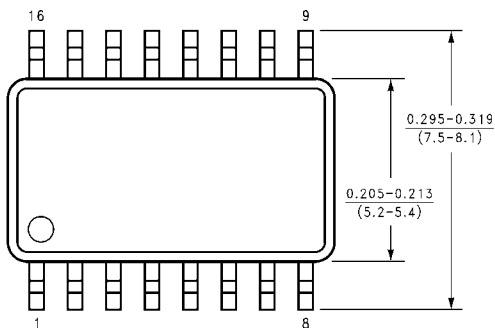

**16-Lead Small Outline Package (SOP), EIAJ TYPE II, 5.3mm Wide Package Number M16D**

**Physical Dimensions** inches (millimeters) unless otherwise noted (Continued)

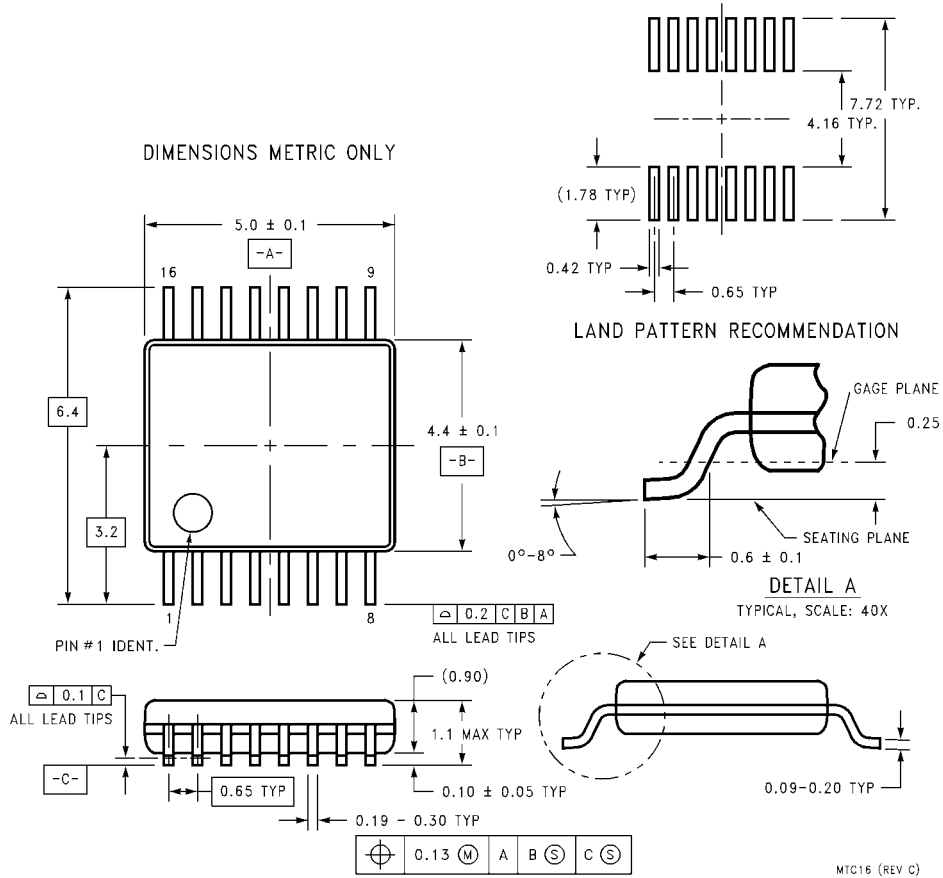

**16-Lead Thin Shrink Small Outline Package (TSSOP), JEDEC MO-153, 4.4mm Wide  
Package Number MTC16**



**Physical Dimensions** inches (millimeters) unless otherwise noted (Continued)

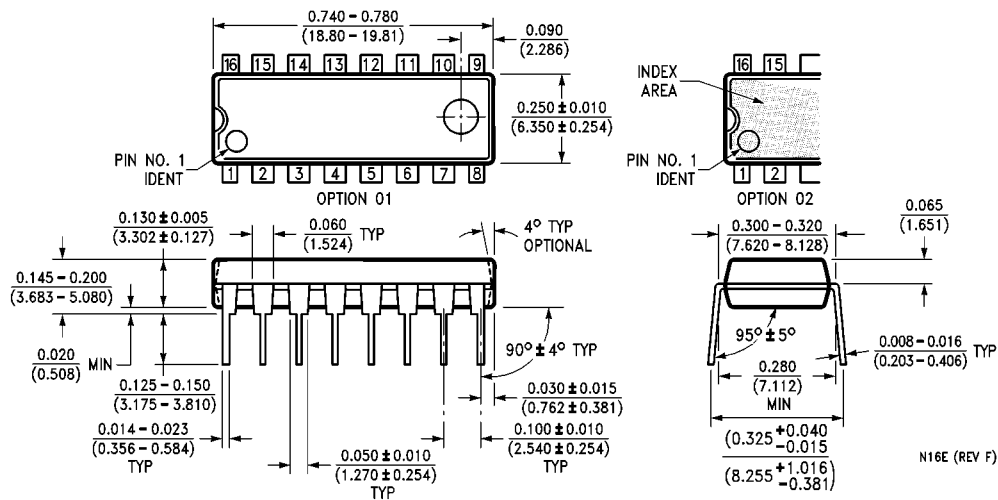

**16-Lead Plastic Dual-In-Line Package (PDIP), JEDEC MS-001, 0.300" Wide  
Package Number N16E**

**LIFE SUPPORT POLICY**

FAIRCHILD'S PRODUCTS ARE NOT AUTHORIZED FOR USE AS CRITICAL COMPONENTS IN LIFE SUPPORT DEVICES OR SYSTEMS WITHOUT THE EXPRESS WRITTEN APPROVAL OF THE PRESIDENT OF FAIRCHILD SEMICONDUCTOR CORPORATION. As used herein:

1. Life support devices or systems are devices or systems which, (a) are intended for surgical implant into the body, or (b) support or sustain life, and (c) whose failure to perform when properly used in accordance with instructions for use provided in the labeling, can be reasonably expected to result in a significant injury to the user.
2. A critical component in any component of a life support device or system whose failure to perform can be reasonably expected to cause the failure of the life support device or system, or to affect its safety or effectiveness.

[www.fairchildsemi.com](http://www.fairchildsemi.com)