

SMD Inductors(Coils) For Signal Line(Multilayer, Magnetic Shielded)

Conformity to RoHS Directive

MLF Series MLF1608

FEATURES

- High-reliability monolithic structure.
- Ferrite core and magnetic shielding enables the design of compact circuits with high packing density.
- Excellent solderability and high heat resistance permits either flow or reflow soldering.
- The products contain no lead and also support lead-free soldering.
- It is a product conforming to RoHS directive.

APPLICATIONS

Digital cellular phone, tuner, personal computers, audio, or various electronic appliances.

SPECIFICATIONS

Operating temperature range	-40 to +85°C
Storage temperature range	-40 to +85°C

RECOMMENDED SOLDERING CONDITION REFLOW SOLDERING

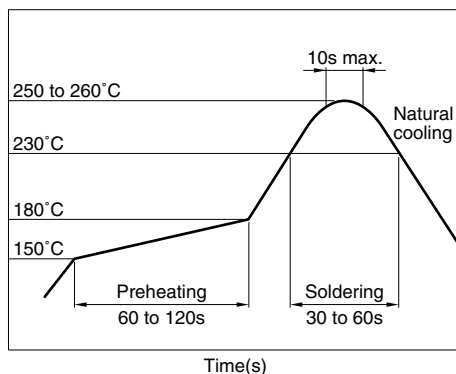

PRODUCT IDENTIFICATION

MLF	1608	A	1R0	K	T
(1)	(2)	(3)	(4)	(5)	(6)

(1) Series name

(2) Dimensions L×W

1608	1.6×0.8mm
------	-----------

(3) Material code

(4) Inductance value

47N	47nH[0.047μH]
R15	0.15μH
1R0	1μH

(5) Inductance tolerance

K	±10%
M	±20%

(6) Packaging style

T	Taping [reel]
---	---------------

PACKAGING STYLE AND QUANTITIES

Packaging style	Product's thickness	Quantity
Taping	0.8mm	4000 pieces/reel

HANDLING AND PRECAUTIONS

- Before soldering, be sure to preheat components.
The preheating temperature should be set so that the temperature difference between the solder temperature and product temperature does not exceed 150°C.
- After mounting components onto the printed circuit board, do not apply stress through board bending or mishandling.
- The inductance value may change due to magnetic saturation if the current exceeds the rated maximum.
- Do not expose the inductors to stray magnetic fields.
- Avoid static electricity discharge during handling.
- When hand soldering, apply the soldering iron to the printed circuit board only. Temperature of the iron tip should not exceed 350°C. Soldering time should not exceed 3 seconds.

• Conformity to RoHS Directive: This means that, in conformity with EU Directive 2002/95/EC, lead, cadmium, mercury, hexavalent chromium, and specific bromine-based flame retardants, PBB and PBDE, have not been used, except for exempted applications.

• Please contact our Sales office when your application are considered the following:
The device's failure or malfunction may directly endanger human life (e.g. application for automobile/aircraft/medical/nuclear power devices, etc.)

• All specifications are subject to change without notice.

SHAPES AND DIMENSIONS/RECOMMENDED PC BOARD PATTERN

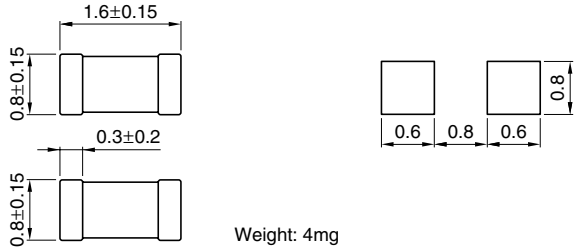

ELECTRICAL CHARACTERISTICS

Inductance (μH)	Inductance tolerance	Q		Test frequency L, Q (MHz)	Test current L, Q (mA)	Self-resonant frequency (MHz)		DC resistance (Ω)		Rated current (mA)max.	Thickness T (mm)	Part No.
		min.	typ.			min.	typ.	max.	typ.			
0.047	$\pm 20\%$	10	20	50	1.0	600	900	0.20	0.10	200	0.8	MLF1608D47N*1MT
0.068	$\pm 20\%$	10	20	50	1.0	550	700	0.30	0.15	200	0.8	MLF1608D68NMT
0.082	$\pm 20\%$	10	20	50	1.0	500	650	0.30	0.15	200	0.8	MLF1608D82NMT
0.1	$\pm 20, \pm 10\%$	15	25	25	1.0	450	600	0.35	0.20	200	0.8	MLF1608DR10□*2T
0.12	$\pm 20, \pm 10\%$	15	25	25	1.0	400	550	0.40	0.20	200	0.8	MLF1608DR12□T
0.15	$\pm 20, \pm 10\%$	15	25	25	1.0	350	500	0.45	0.25	200	0.8	MLF1608DR15□T
0.18	$\pm 20, \pm 10\%$	15	25	25	1.0	320	450	0.50	0.25	150	0.8	MLF1608DR18□T
0.22	$\pm 20, \pm 10\%$	15	25	25	1.0	290	400	0.55	0.30	150	0.8	MLF1608DR22□T
0.27	$\pm 20, \pm 10\%$	15	25	25	1.0	260	350	0.60	0.35	150	0.8	MLF1608DR27□T
0.33	$\pm 20, \pm 10\%$	15	25	25	1.0	230	320	0.75	0.40	100	0.8	MLF1608DR33□T
0.39	$\pm 20, \pm 10\%$	15	25	25	1.0	210	290	0.85	0.45	100	0.8	MLF1608DR39□T
0.47	$\pm 20, \pm 10\%$	15	30	25	1.0	190	260	0.95	0.50	100	0.8	MLF1608DR47□T
0.56	$\pm 20, \pm 10\%$	15	30	25	1.0	170	230	1.05	0.55	100	0.8	MLF1608DR56□T
0.68	$\pm 20, \pm 10\%$	15	30	25	1.0	150	210	1.25	0.65	70	0.8	MLF1608DR68□T
0.82	$\pm 20, \pm 10\%$	15	30	25	1.0	130	190	1.40	0.75	70	0.8	MLF1608DR82□T
1	$\pm 20, \pm 10\%$	35	50	10	1.0	120	170	0.50	0.25	50	0.8	MLF1608A1R0□T
1.2	$\pm 20, \pm 10\%$	35	50	10	1.0	110	150	0.65	0.25	50	0.8	MLF1608A1R2□T
1.5	$\pm 20, \pm 10\%$	35	55	10	1.0	100	140	0.70	0.30	50	0.8	MLF1608A1R5□T
1.8	$\pm 20, \pm 10\%$	35	55	10	1.0	90	130	0.85	0.35	50	0.8	MLF1608A1R8□T
2.2	$\pm 20, \pm 10\%$	35	55	10	1.0	80	120	1.00	0.45	30	0.8	MLF1608A2R2□T
2.7	$\pm 20, \pm 10\%$	35	55	10	1.0	70	110	1.15	0.50	30	0.8	MLF1608A2R7□T
3.3	$\pm 20, \pm 10\%$	35	60	10	1.0	65	100	1.30	0.55	30	0.8	MLF1608A3R3□T
3.9	$\pm 20, \pm 10\%$	35	60	10	1.0	60	90	1.45	0.65	30	0.8	MLF1608A3R9□T
4.7	$\pm 20, \pm 10\%$	35	60	10	1.0	55	80	1.60	0.75	30	0.8	MLF1608A4R7□T
5.6	$\pm 20, \pm 10\%$	35	60	4	0.1	45	70	1.10	0.55	15	0.8	MLF1608E5R6□T
6.8	$\pm 20, \pm 10\%$	35	60	4	0.1	40	60	1.30	0.65	15	0.8	MLF1608E6R8□T
8.2	$\pm 20, \pm 10\%$	35	60	4	0.1	35	55	1.50	0.80	10	0.8	MLF1608E8R2□T
10	$\pm 20, \pm 10\%$	30	55	2	0.1	30	50	1.70	1.00	10	0.8	MLF1608E100□T
12	$\pm 20, \pm 10\%$	30	55	2	0.1	25	45	1.80	1.20	10	0.8	MLF1608E120□T
15	$\pm 20, \pm 10\%$	20	40	1	0.1	22	42	1.50	0.80	2	0.8	MLF1608C150□T
18	$\pm 20, \pm 10\%$	20	40	1	0.1	20	40	1.60	0.85	2	0.8	MLF1608C180□T
22	$\pm 20, \pm 10\%$	20	40	1	0.1	18	38	1.70	0.90	2	0.8	MLF1608C220□T
27	$\pm 20, \pm 10\%$	20	40	1	0.1	15	35	1.80	1.20	2	0.8	MLF1608C270□T
33	$\pm 20, \pm 10\%$	20	40	1	0.1	10	30	2.20	1.40	2	0.8	MLF1608C330□T

*1 47N means for 47nH (0.047 μH).

*2 □: Please specify inductance tolerance, M($\pm 20\%$) or K($\pm 10\%$).

• Test equipment

Inductance, Q: Ag4294A-16034G

TYPICAL ELECTRICAL CHARACTERISTICS INDUCTANCE CHANGE vs. DC SUPERPOSITION CHARACTERISTICS

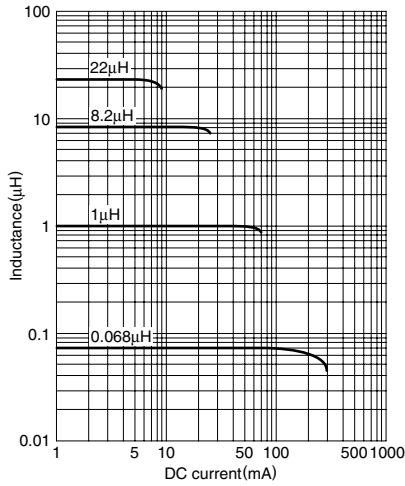

IMPEDANCE vs. FREQUENCY CHARACTERISTICS

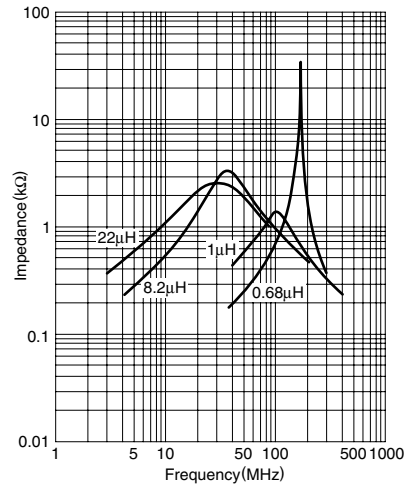

INDUCTANCE CHANGE vs. TEMPERATURE CHARACTERISTICS

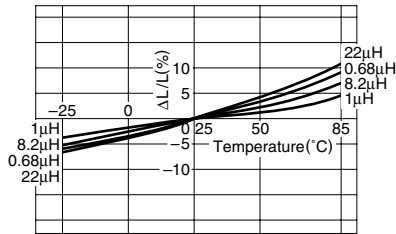

Q vs. FREQUENCY CHARACTERISTICS

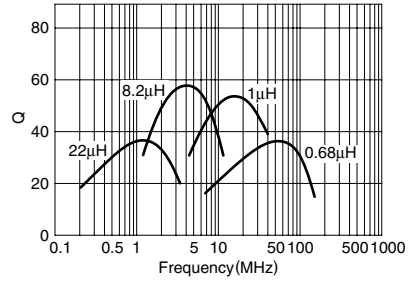

PACKAGING STYLES REEL DIMENSIONS

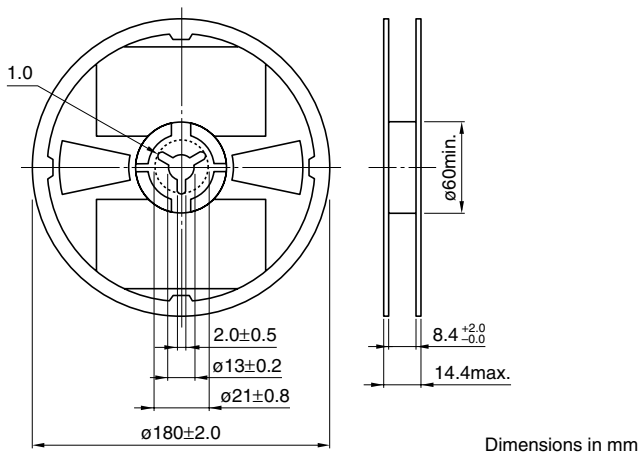

Dimensions in mm

TAPE DIMENSIONS

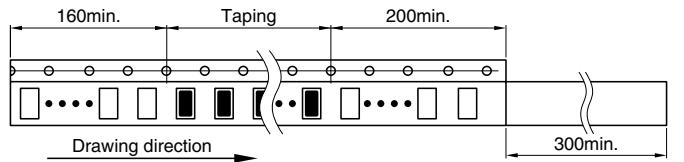
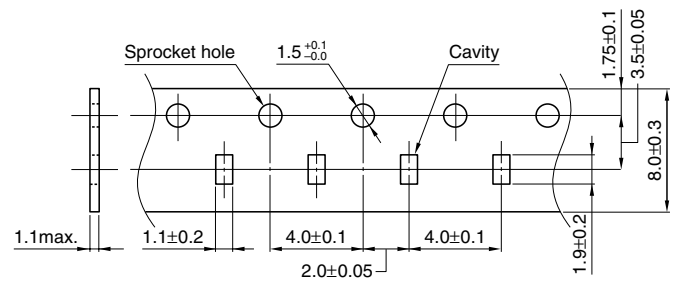

Dimensions in mm

• All specifications are subject to change without notice.